

[catálogo de Productos]

Aceros y metales de alta calidad



Copper**metal**



Introducción

Fundada en 1991, con más de 30 años de historia, COPPERMETAL tiene un compromiso serio con la calidad y el servicio de excelencia con sus más de 30.000 clientes ya atendidos.

Tenemos la certificación ISO 9001 y eso significa que estamos listos para satisfacer su demanda con alta eficiencia en los procesos, entregar productos de calidad y proporcionar una atención postventa adecuadamente satisfactoria.

Sumario



COBRE

- 07. Principales aleaciones, formatos, características y aplicaciones
- 08. Composición química del cobre
- 09. Propiedades mecánicas del cobre
- 10. Propiedades físicas del cobre



ALUMÍNIO

- 23. Principales aleaciones, formatos, características y aplicaciones
- 28. Composición química del aluminio
- 31. Propiedades mecánicas del aluminio
- 34. Propiedades físicas del aluminio



BRONCE

- 53. Principales aleaciones, formatos, características y aplicaciones
- 56. Composición química del bronce
- 60. Propiedades mecánicas del bronce
- 65. Propiedades físicas del bronce



LATÓN

- 86. Principales aleaciones, formatos, características y aplicaciones
- 89. Composición química del latón
- 91. Propiedades mecánicas del latón
- 94. Propiedades físicas del latón



ACERO INOXIDABLE

- 106. Composición química y mecánica



ACERO AL CARBONO (FERROSOS)

- 118. Aleaciones y formatos
- 120. Propiedades químicas
- 126. Propiedades mecánicas
- 136. Perfil En "U" - En El Estándar Americano
- 141. Tubos estándar Schedule

colobore

The word "colobore" is rendered in a stylized, lowercase font. A white, hollow triangle is positioned behind the first three letters, "col". Each letter of the word contains a different image: the 'c' shows a close-up of a person's face; the 'o' shows a person in a dark setting; the 'l' shows a person in a white coat; the 'o' shows a person in a white coat; the 'r' shows a person in a white coat; and the 'e' shows a person in a white coat. The background is a solid, vibrant red.

Cobre

¡El 3º metal más utilizado en el mundo es el cobre! Un material altamente versátil y eficiente que tiene inúmeras ventajas, como:

- ▶ Facilidades de conformación;
- ▶ Elevada resistencia a la corrosión;
- ▶ Elevada resistencia mecánica;
- ▶ Elevada durabilidad;
- ▶ Acción antimicrobiana;
- ▶ Soporta elevadas temperaturas;
- ▶ Reducida dilatación térmica característica;
- ▶ Estabilidad dimensional;
- ▶ Reciclable;
- ▶ Poca tendencia a la incrustación.

Su campo de aplicaciones se extiende a prácticamente todos los segmentos industriales y sus propiedades lo vuelve una pieza clave en la producción de los más variados productos. Además es un material infinitamente reciclable y tiene propiedades antimicrobianas capaces de eliminar hasta el 99,9% de las bacterias de la superficie.



PRINCIPALES ALEACIONES, FORMATOS, CARACTERÍSTICAS Y APLICACIONES

Denominación	Aleación ASTM/UNS	Formato	Características	Aplicaciones
Cobre Elox	C10200	Tiras	Excelente confortabilidad a frío y buena confortabilidad a caliente. Excelente soldadura y brazaje.	Conductores eléctricos, guías de ola y aplicaciones electrónicas.
Cobre Electrolítico	C11000	Bobinas, Placa/ Plancha, Tiras, Barras Rectangulares, Barras, Tubos,	Excelente confortabilidad a frío y buena confortabilidad a caliente. Excelente soldadura y brazaje.	Cables, conductores, motores, generadores, transformadores. Contactos, fríos conductores, componentes de radio y televisión, calderas, tanques, juntas automotoras, radiadores, canaletas, pliegos, rebites, ánodos.
Cobre Fosforoso (DLP)	C12000	Bobinas, Placa/ Plancha, Tiras	Excelente confortabilidad a frío y a caliente. Excelente soldadura y brazaje.	Junta de motores, arandelas de sellado, piezas de artesanado, frentes de predios, placas de calentadores solares, calentadores eléctricos, canaletas y conductores de residencia, rebites.
Cobre Fosforoso (DHP)	C12200	Tubos, Ánodos	Excelente confortabilidad a frío y buena confortabilidad a caliente. Excelente soldadura y brazaje.	Aparatos de aire acondicionado y refrigeración, tubos para conducción de agua caliente, fría y gas, evaporadores, intercambiadores de calor, radiadores.
Cobre Cromo	C18400	Barras	Buena confortabilidad a frío y a caliente. Buena soldadura y brazaje.	Electrodos para suelda, puntas de soplete y hierros de soldar, en todas aquellas que exijan características mecánicas superiores a las del cobre, conservando al mismo tiempo conductibilidad térmica y eléctrica alta.
Cuproníquel 90/10	C70600	Tubos	Buena confortabilidad a frío y a caliente. Excelente soldadura y brazaje.	Tubos y conexiones para acondicionadores e intercambiadores de calor, evaporadores, tubos para agua ensalada.
Cuproníquel 70/30	C71500	Tubos	Buena confortabilidad a frío y a caliente. Excelente soldadura y brazaje	Condensadores, tubos de destilarías, tubos de evaporadores e intercambiadores de calor, tubos para agua ensalada.

COMPOSICIÓN QUÍMICA DEL COBRE

Denominación	Aleación	Cu	Zn	Pb	P	Sn	Fe	Si	Ni	Mn	Otros
	ASTM / UNS	(%)	(%)	(%)	(%)	(%)	(%)	(%)	(%)	(%)	(%)
Cobre Electrolítico	C11000	99.9 (mín.)									
Cobre Fosforoso (DLP)	C12000	99.9 (mín.)			0,004 0,012						
Cobre Fosforoso (DHP)	C12200	99.9 (mín.)			0.015 0.040						
Cobre Cromo	C18400	99.8 (mín.)	0.7		0.05		0.15	0.10			Cr=0,40 1.2
Cuproníquel 90/10	C70600	restante	1.00	0.05			1.00 1.8		9 11	1.00	
Cuproníquel 70/30	C71500	restante	1.00	0.05			0.4 1.00		29 33	1.00	
Cobre Elox	C10200	99.95 (mín.)									

Notas:

1. Los valores mencionados representan límites máximos por elemento químico, salvo si se indican intervalos entre mínimo y máximo.
2. Los valores indicados no darán lugar a garantía formal.

PROPIEDADES MECÁNICAS DEL COBRE

Denominación	Aleación ASTM/UNS	Formato	Temple	Límite de Resistencia a la Tracción (kgf/mm ²)	Límite de Fluencia (kgf/mm ²)	Alargamiento Mínimo "50,80 mm" (%)	Dureza Brinell (HB)
Cobre Elox	C10200	Tiras	Recocido	22	5	48	45
			1/2 Duro	32	27	12	90
Cobre Electrolítico	C11000	Bobinas, placa/ planchas, tiras, barras rectangulares	Recocido	22	5	48	45
			1/2 Duro	32	27	12	90
Cobre Electrolítico	C11000	Barras	1/2 Duro	28	19	20	75
Cobre Electrolítico	C11000	Tubos	1/2 Duro	32	27	15	90
Cobre Fosforoso (DLP)	C12000	Bobinas, placa/ planchas, tiras	Recocido	22	5	48	45
			1/2 Duro	32	27	12	90
Cobre Fosforoso (DHP)	C12200	Tubos	Recocido	24	6	45	45
			1/2 Duro	35	30	8	100
			Duro	38	35	6	105
Cobre Cromo	C18400	Barras (trefilados)	Duro	52	52	15	137
Cuproníquel 90/10	C70600	Tubos	Recocido	31	11	42	60
Cuproníquel 70/30	C71500	Tubos	Recocido	42	18	45	74

Notas: Los valores indicados no darán lugar a garantía formal.

PROPIEDADES FÍSICAS DEL COBRE

Denominación	Aleaciones ASTM/UNS	Densidad a 20 °C p=peso específico (g/cm ³)	Punto de Fusión (°C)	Conductividad Térmica a 20 °C (cal/cm/seg °C)	Calor Específico a 20 °C (cal/g °C)	Resistividad Eléctrica a 20 °C (material recocido) (μΩ cm)	Conductividad Eléctrica a 20 °C (material recocido) (%IACS)	Coefficiente de Expansión Térmica 20 a 300 °C (10 ⁻⁶ °C)	Módulo de Elasticidad a 20 °C (kg/mm ²)	Módulo de Rigidez a 20 °C (kg/mm ²)
Cobre Elox	C10200	8.90	1,083	0.94	0.092	1.710	101	17.7	12,000	4,500
Cobre Electrolítico	C11000	8.90	1,083	0.94	0.092	1.710	101	17.7	12,000	4,500
Cobre Fosforoso (DLP)	C12000	8.94	1,083	0.91	0.092	1.760	98	17.7	12,000	4,500
Cobre Fosforoso (DHP)	C12200	8.94	1,083	0.81	0.092	2.030	85	17.7	12,000	4,500
Cobre Cromo	C18400	8.89	1,080	0.75	0.092	2.100	82	18	16,000	5,900
Cuproníquel 90/10	C70600	8.94	1,150	0.11	0.090	19.100	9	17.1	12,700	4,800
Cuproníquel 70/30	C71500	8.94	1,240	0.07	0.090	37.500	5	16.2	15,500	5,800

Notas: Los valores indicados no darán lugar a garantía formal.

VARILLAS - PESO POR METRO LINEAL

Pulgada	Milímetro	●	⬡	■
3/32"	2,38	0,040	0,044	0,050
1/8"	3,17	0,070	0,077	0,089
5/32"	3,97	0,110	0,121	0,140
3/16"	4,76	0,158	0,175	0,202
7/32"	5,56	0,216	0,238	0,275
1/4"	6,35	0,282	0,311	0,359
9/32"	7,14	0,356	0,393	0,454
5/16"	7,94	0,441	0,486	0,561
3/8"	9,53	0,635	0,700	0,808
7/16"	11, 11	0,863	0,951	1,099
1/2"	12,70	1,127	1,243	1,435
9/16"	14,28	1,425	1,572	1,815
5/8"	15,87	1,760	1,941	2,242
11/16"	17,46	2,131	2,350	2,713
3/4"	19,05	2,537	2,797	3,230
13/16"	20,63	2,975	3,280	3,788
7/8"	22,22	3,451	3,805	4,394

Pulgada	Milímetro	●	⬡	■
15/16"	23,81	3,963	4,369	5,046
1"	25,40	4,510	4,973	5,742
1.1/16"	26,97	5,084	5,606	6,474
1.1 /8"	28,57	5,706	6,291	7,265
1.3/16"	30,16	6,358	7,011	8,096
1.1 /4"	31,75	7,046	7,770	8,972
1.5/16"	33,34	7,770	8,567	9,893
1.3/8"	34,92	8,524	9,398	10,853
1.7/16"	36,51	9,318	10,274	11,864
1.1/2"	38,10	10,147	11,188	12,919
1.9/16"	39,69	11,011	12,141	14,020
1.5/8"	41,27	11,906	13,127	15,159

VARILLAS - PESO POR METRO LINEAL

Pulgada	Milímetro	●	⬡	■
1.3/4"	44,45	13,811	15,228	17,585
1.7/8"	47,62	15,851	17,478	20,182
2"	50,80	18,039	19,890	22,968
2.1/16"	52,39	19,186	21,155	24,428
2.1/8"	53,97	20,360	22,450	25,924
2.3/16"	55,56	21,578	23,792	27,474
2.1/4"	57,15	22,830	25,173	29,068
2.5/16"	58,73	24,110	26,584	30,698
2.3/8"	60,33	25,442	28,053	32,393
2.7/16"	61,91	26,792	29,541	34,112
2.1/2"	63,50	28,186	31,078	35,887
2.5/8"	66,67	31,070	34,259	39,560
2.3/4"	69,85	34,105	37,605	43,423
2.7/8"	73,03	37,281	41,106	47,467
3"	76,20	40,587	44,753	51,677
3.1/8"	79,37	44,035	48,554	56,066

Pulgada	Milímetro	●	⬡	■
3.3/8"	85,73	51,374	56,647	65,412
3.1/2"	88,90	55,244	60,913	70,339
3.5/8"	92,07	59,254	65,335	75,444
3.3/4"	95,25	63,418	69,926	80,746
3.7/8"	98,42	67,709	74,658	86,210
4"	101,60	72,155	79,560	91,871
4.1/2"	114,30	91,322	100,693	116,274
5"	127,00	112,743	124,313	143,548
6"	152,40	162,349	179,010	206,709
7"	177,80	220,976	243,653	281,354
8"	203,20	288,621	318,240	367,483

BARRAS RECTANGULARES - PESO POR METRO LINEAL

Pulgadas/mm		1/16" 1,58mm	3/32" 2,38mm	1/8" 3,17mm	3/16" 4,76mm	1/4" 6,35mm	5/16" 7,94mm	3/8" 9,53mm	1/2" 12,70mm	5/8" 15,87mm	3/4" 19,05mm	1" 25,40mm
1/4"	6,35	1,180	0,135	0,179	0,269	---	---	---	---	---	---	---
5/16"	7,94	0,112	0,168	0,224	0,336	0,449	---	---	---	---	---	---
3/8"	9,53	0,134	0,202	0,269	0,404	0,539	0,673	---	---	---	---	---
7/16"	11,11	0,156	0,235	0,313	0,471	0,628	0,785	0,942	---	---	---	---
1/2"	12,70	0,179	0,269	0,358	0,538	0,718	0,897	1,077	---	---	---	---
9/16"	14,29	0,201	0,303	0,403	0,605	0,808	1,010	1,212	1,615	---	---	---
5/8"	15,87	0,223	0,336	0,448	0,672	0,897	1,121	1,346	1,794	---	---	---
11/16"	17,46	0,246	0,370	0,493	0,740	0,987	1,234	1,481	1,974	2,466	---	---
3/4"	19,05	0,268	0,404	0,537	0,807	1,077	1,346	1,616	2,153	2,691	---	---
7/8"	22,22	0,312	0,471	0,627	0,941	1,256	1,570	1,885	2,512	3,138	3,767	---
1"	25,40	0,357	0,538	0,717	1,076	1,435	1,795	2,154	2,871	3,588	4,306	---
1.1/8"	28,57	0,402	0,605	0,806	1,210	1,615	2,019	2,423	3,229	4,035	4,844	---
1.1/4"	31,75	0,446	0,673	0,896	1,345	1,794	2,244	2,693	3,589	4,484	5,383	7,177
1.3/8"	34,93	0,491	0,740	0,985	1,480	1,974	2,468	2,963	3,948	4,934	5,922	7,896
1.1/2"	38,10	0,536	0,807	1,075	1,614	2,153	2,692	3,232	4,306	5,381	6,460	8,613

BARRAS RECTANGULARES - PESO POR METRO LINEAL

Pulgadas/mm		1/16" 1,58mm	3/32" 2,38mm	1/8" 3,17mm	3/16" 4,76mm	1/4" 6,35mm	5/16" 7,94mm	3/8" 9,53mm	1/2" 12,70mm	5/8" 15,87mm	3/4" 19,05mm	1" 25,40mm
1.5/8"	41,27	0,580	0,874	1,164	1,748	2,332	2,916	3,500	4,665	5,829	6,997	9,329
1.3/4"	44,45	0,625	0,942	1,254	1,883	2,512	3,141	3,770	5,024	6,278	7,536	10,048
1.7/8"	47,62	0,670	1,009	1,344	2,017	2,691	3,365	4,039	5,382	6,726	8,074	10,765
2"	50,80	0,714	1,076	1,433	2,152	2,871	3,590	4,309	5,742	7,175	8,613	11,484
2.1/4"	57,15	0,804	1,211	1,612	2,421	3,230	4,039	4,847	6,460	8,072	9,689	12,919
2.1/2"	63,50	0,893	1,345	1,792	2,690	3,589	4,487	5,386	7,177	8,969	10,766	14,355
2.3/4"	69,85	0,982	1,480	1,971	2,959	3,948	4,936	5,924	7,895	9,866	11,843	15,790
3"	76,20	1,072	1,614	2,150	3,228	4,306	5,385	6,463	8,613	10,763	12,919	17,226
3.1/4"	82,55	1,161	1,749	2,329	3,497	4,665	5,833	7,002	9,331	11,660	13,996	18,661
3.1/2"	88,90	1,250	1,883	2,508	3,766	5,024	6,282	7,540	10,048	12,557	15,073	20,097
3.3/4"	95,25	1,339	2,018	2,687	4,035	5,383	6,731	8,079	10,766	13,453	16,149	21,532
4"	101,60	1,429	2,152	2,866	4,304	5,742	7,180	8,617	11,484	14,350	17,226	22,968

COBRE

BARRAS RECTANGULARES - PESO POR METRO LINEAL

Pulgadas/mm		1/16" 1,58mm	3/32" 2,38mm	1/8" 3,17mm	3/16" 4,76mm	1/4" 6,35mm	5/16" 7,94mm	3/8" 9,53mm	1/2" 12,70mm	5/8" 15,87mm	3/4" 19,05mm	1" 25,40mm
4.1/2"	114,30	1,607	2,421	3,225	4,842	6,460	8,077	9,695	12,919	16,144	19,379	25,839
5"	127,00	1,786	2,690	3,583	5,380	7,177	8,975	10,772	14,355	17,938	21,532	28,710
5.1/2"	139,70	1,964	2,959	3,941	5,918	7,895	9,872	11,849	15,790	19,732	23,685	31,581
6"	152,40	2,143	3,228	4,300	6,456	8,613	10,769	12,926	17,226	21,525	25,839	34,452
6.1/2"	165,10			4,658	6,994	9,331	11,667	14,003	18,661	23,319	27,992	37,323
7"	177,80			5,016	7,532	10,048	12,564	15,080	20,097	25,113	30,145	40,193
7.1/2"	190,50			5,375	8,070	10,766	13,462	16,158	21,532	26,907	32,298	43,064
8"	203,20			5,733	8,608	11,484	14,359	17,235	22,968	28,701	34,452	45,935

AMPERAJE PARA BARRAS RECTANGULARES - CORRIENTE AMPERIO POR MM²

Pulgadas/mm		1/16" 1,58mm	3/32" 2,38mm	1/8" 3,17mm	3/16" 4,76mm	1/4" 6,35mm	5/16" 7,94mm	3/8" 9,53mm	1/2" 12,70mm	5/8" 15,87mm	3/4" 19,05mm	1" 25,40mm
1/4"	6,35	20	30	40	---	---	---	---	---	---	---	---
5/16"	7,94	25	38	50	---	---	---	---	---	---	---	---
3/8"	9,53	30	45	60	91	121	---	---	---	---	---	---
1/2"	12,70	40	60	81	121	161	202	242	---	---	---	---
5/8"	15,87	50	76	101	151	202	252	302	403	---	---	---
3/4"	19,05	60	91	121	181	242	303	363	484	---	---	---
7/8"	22,22	70	106	141	212	282	353	423	564	---	---	---
1"	25,40	80	121	161	242	323	403	484	645	806	968	---
1.1/4"	31,75	100	151	201	302	403	504	605	806	1008	1210	1613
1.1/2"	38,10	120	181	242	363	484	605	725	968	1209	1452	1935
1.5/8"	41,27	130	196	262	393	524	655	786	1048	1310	1572	2097
1.3/4"	44,45	140	212	282	423	565	706	846	1129	1411	1694	2258
2"	50,80	161	242	322	484	645	807	967	1290	1612	1935	2581
2.1/4"	57,15	181	272	362	544	726	908	1088	1452	1814	2177	2903
2.1/2"	63,50	201	302	403	605	806	1008	1209	1613	2015	2419	3226
2.3/4"	69,85	221	332	443	665	887	1109	1330	1774	2217	2661	3548

AMPERAJE PARA BARRAS RECTANGULARES - CORRIENTE AMPERIO POR MM²

Pulgadas/mm		1/16" 1,58mm	3/32" 2,38mm	1/8" 3,17mm	3/16" 4,76mm	1/4" 6,35mm	5/16" 7,94mm	3/8" 9,53mm	1/2" 12,70mm	5/8" 15,87mm	3/4" 19,05mm	1" 25,40mm
3"	76,20	241	363	483	725	968	1210	1451	1935	2419	2903	3871
3.1/4"	82,55	261	393	523	786	1048	1311	1572	2097	2620	3145	4194
3.1/2"	88,90	281	423	564	846	1129	1412	1693	2258	2822	3387	4516
3.3/4"	95,25	301	453	604	907	1210	1513	1814	2419	3023	3629	4839
4"	101,60	321	484	644	967	1290	1613	1934	2581	3225	3871	5161
4.1/2"	114,30	---	---	725	1088	1452	1815	2176	2903	3628	4355	5806
5"	127,00	---	---	805	1209	1613	2017	2418	3226	4031	4839	6452
5.1/2"	139,70	---	---	886	1330	1774	2218	2660	3548	4434	5323	7097
6"	152,40	---	---	966	1451	1935	2420	2902	3871	4837	5806	7742
6.1/2"	165,10	---	---	1047	1572	2097	2622	3144	4194	5240	6290	8387
7"	177,80	---	---	1127	1693	2258	2823	3385	4516	5643	6774	9032
7.1/2"	190,50	---	---	1208	1814	2419	3025	3627	4839	6046	7258	9677
8"	203,20	---	---	1288	1934	2581	3227	3869	5161	6450	7742	10323

Notas: Coeficiente de amperaje utilizado 2A/mm²

TUBOS - PESO POR METRO LINEAL

Diámetro externo		Espesor de la pared					Diámetro externo		Espesor de la pared				
Pulgadas	Mm	1/32" 0,79 mm	1,00 mm	1/16" 1,58 mm	3/32" 2,38 mm	1/8" 3,17 mm	Pulgadas	Mm	1/32" 0,79 mm	1,00 mm	1/16" 1,58 mm	3/32" 2,38 mm	1/8" 3,17 mm
1/8"	3,17	0,053	0,061	---	---	---	1.1/2"	38,10	0,824	1,040	1,620	2,380	3,100
5/32"	3,97	0,070	0,083	0,105	---	---	1.5/8"	41,27	0,893	1,130	1,760	2,590	3,380
3/16"	4,76	0,088	0,105	0,141	---	---	1.3/4"	44,45	0,964	1,210	1,910	2,800	3,660
1/4"	6,35	0,123	0,150	0,212	0,264	---	1.7/8"	47,62	1,030	1,300	2,050	3,010	3,940
5/16"	7,94	0,158	0,194	0,282	0,370	0,422	2"	50,80	1,100	1,390	2,190	3,220	4,220
3/8"	9,53	0,193	0,238	0,353	0,475	0,563	2.1/8"	53,97	1,170	1,480	2,330	3,430	4,500
7/16"	11,11	0,228	0,283	0,423	0,581	0,704	2.1/4"	57,15	1,240	1,570	2,470	3,640	4,780
1/2"	12,70	0,263	0,327	0,494	0,687	0,844	2.3/8"	60,33	1,310	1,660	2,610	3,860	5,070
9/16"	14,28	0,298	0,372	0,565	0,793	0,985	2.1/2"	63,50	1,390	1,750	2,750	4,060	5,350
5/8"	15,87	0,333	0,416	0,635	0,898	1,130	2.5/8"	66,67	1,460	1,840	2,890	4,280	5,630
3/4"	19,05	0,403	0,505	0,776	1,110	1,410	2.3/4"	69,85	1,530	1,930	3,030	4,490	5,910
7/8"	22,22	0,473	0,593	0,918	1,320	1,609	3"	76,20	1,670	2,100	3,320	4,910	6,470
1"	25,40	0,544	0,682	1,060	1,530	1,970	3.1/4"	82,55	---	---	---	5,392	7,111
1.1/8"	28,57	0,614	0,771	1,200	1,740	2,250	3.1/2"	88,90	---	---	---	5,910	7,830
1.1/4"	31,75	0,684	0,860	1,340	1,950	2,530	3.3/4"	95,25	---	---	---	6,243	8,300
1.3/8"	34,92	0,754	0,948	1,480	2,170	2,810	4"	101,60	---	---	---	6,673	8,719

cobre

TUBOS HIDROLAR - PESO POR METRO LINEAL

Clase "E"			
Diámetro nominal	Diámetro externo x Espesor de pared (mm)	Peso (kg/m)	Presión interna (kgf/cm ²)
1/2"	15,00 x 0,50	1,213	41
3/4"	22,00 X 0,60	0,360	34
1"	28,00 X 0,60	0,460	26
1.1/4"	35,00 X 0,70	0,673	25
1.1 /2"	42,00 X 0,80	0,923	24
2"	54,00 X 0,90	1,339	21
2.1/2"	66,70 X 1,00	1,839	20
3"	79,40 X 1,20	2,627	19
4"	104,80 X 1,20	3,480	14

Clase "A"			
Diámetro nominal	Diámetro externo x Espesor de pared (mm)	Peso (kg/m)	Presión interna (kgf/cm ²)
1/2"	15,00 X 1,50	0,318	65
3/4"	22,00 X 0,90	0,532	50
1"	28,00 X 0,90	0,683	40
1.1/4"	35,00 X 1,10	1,045	40
1.1 /2"	42,00 X 1,10	1,261	35
2"	54,00 X 1,20	1,775	28
2.1/2"	66,70 X 1,20	2,200	24
3"	79,40 X 1,50	3,271	24
4"	104,80 X 1,50	4,337	18

Clase "I"			
Diámetro nominal	Diámetro externo x Espesor de pared (mm)	Peso (kg/m)	Presión interna (kgf/cm ²)
1/2"	15,00 X 1,00	0,392	88
3/4"	22,00x1,10	0,644	60
1"	28,00 X 1,20	0,901	55
1.1/4"	35,00 X 1,40	1,318	45
1.1/2"	42,00 X 1,40	1,593	42
2"	54,00 X 1,50	2,206	34
2.1/2"	66,70x1,50	2,737	28
3"	79,40 X 1,90	4,122	27
4"	104,80x2,00	5,755	20

cobre

CHAPAS - PESO POR PIEZA

Nº. (BWG)	Mm	1.200 X 600mm	2.000 X 1.000mm
30	0,30	1,92	---
28	0,36	2,31	---
27	0,41	2,63	---
26	0,46	2,95	---
25	0,51	3,27	9,08
24	0,56	3,59	9,97
23	0,64	4,10	11,39
22	0,71	4,55	12,64
21	0,81	5,19	14,42
20	0,89	5,70	15,84
19	1,07	6,86	19,05
18	1,24	7,95	22,07
17	1,47	9,42	26,17

Nº. (BWG)	Mm	1.200 X 600mm	2.000 X 1.000mm
16	1,65	10,57	29,37
15	1,83	11,73	32,57
14	2, 11	13,52	37,56
13	2,41	15,44	42,90
12	2,77	17,75	49,31
11	3,04	19,48	54,11
---	3,17	20,31	56,43
10	3,40	21,79	60,52
---	3,97	25,44	70,67
---	4,76	30,50	84,73
---	6,35	40,69	113,03
---	7,93	50,82	141,15
---	9,53	61,07	169,63

Nº. (BWG)	Mm	1.200 X 600mm	2.000 X 1.000mm
---	12,70	81,38	226,06
---	15,87	101,69	282,49
---	19,05	122,07	339,09
---	22,22	142,39	395,52
---	25,40	162,76	452,12
---	31,75	205,74	---
---	38,10	246,89	---
---	44,45	288,04	---
---	50,80	329,18	---
---	55,58	360,16	---
---	63,50	411,48	---
---	76,20	493,78	---
---	101,4	657,07	---

aluminio

The word "aluminio" is rendered in a bold, lowercase, sans-serif font. Each letter is filled with a different industrial scene, likely from an aluminum processing plant, showing large rolls of metal and machinery. To the right of the word is a white, hollow, right-angled triangle pointing downwards and to the right.

Aluminio

El aluminio es el elemento metálico más abundante de la tierra. Su liviandad, conductividad eléctrica, resistencia a la corrosión y bajo punto de fusión le confiere una amplia gama de aplicaciones. Algunas de sus características son:

- ▶ Alta maleabilidad;
- ▶ Tiene propiedades antimagnéticas;
- ▶ Alta conductibilidad eléctrica y térmica;
- ▶ Alta resistencia a la corrosión;
- ▶ Infinitamente reciclable.

La densidad del aluminio es de, aproximadamente, un tercio del acero o cobre. Es muy maleable y es una excelente opción para la mecanización y fundición.



PRINCIPALES ALEACIONES, FORMATOS, CARACTERÍSTICAS Y APLICACIONES parte 1/5

Aleaciones	Formatos	Características	Aplicaciones
1050	Planchas/Placas	Alta resistencia a la corrosión. Buena confortabilidad y soldadura. Baja resistencia mecánica. Apropiada a anodización decorativa.	Reflectores, luminarias, utensilios domésticos, tanques y cubos estructurales en las industrias química Y alimentaria, intercambiadores de calor.
	Bobinas		
	Tubos		
1100	Planchas/Placas	Alta resistencia a la corrosión. Buena confortabilidad y soldadura. Baja resistencia mecánica. Apropiada a anodización decorativa.	Paneles decorativos, etiquetas metálicas, utensilios domésticos, reflectores, aletas.
	Bobinas		
1200	Planchas/Placas	Alta resistencia a la corrosión. Buena confortabilidad y soldadura. Baja resistencia mecánica. Apropiada a anodización decorativa. Painéis decorativos, etiquetas metálicas,	Paneles decorativos, etiquetas metálicas, utensilios domésticos, reflectores, aletas.
	Bobinas		
1350	Barra redonda	Apropiada a anodización decorativa. Alta soldadura y resistencia a corrosión. Alta conductividad eléctrica. Buena confortabilidad.	Conductores Eléctricos.
	Barras Planas		
	Tubos		
2011	Barra redonda	Alta resistencia mecánica. Buena industria. Mediana resistencia a la corrosión. No recomendada para soldadura.	Piezas de usina en torno automático.
3003	Planchas/Placas	Media resistencia mecánica. Alta resistencia a la corrosión. Buena confortabilidad. Buena soldadura	Intercambiadores de Calor, aislante térmico, industria química, utensilios domésticos, carretero.
	Bobinas		
3104	Planchas/Placas	Buena resistencia a la corrosión. Carreteros para autobuses y camiones, utensilios domésticos, equipos para industria química y alimentaria, latas para bebidas y alimentos, coberturas, canaletas.	Carreteros para autobuses y camiones, utensilios domésticos,
	Bobinas		

PRINCIPALES ALEACIONES, FORMATOS, CARACTERÍSTICAS Y APLICACIONES parte 2/5

Aleaciones	Formatos	Características	Aplicaciones
3105	Planchas/Placas	Buena resistencia mecánica. Alta resistencia mecánica y a la corrosión. Alta confortabilidad. Alta soldadura.	Carreteros de autobuses y camión, piso antideslizante.
	Bobinas		
	Plato de ajedrez de aluminio		
5052	Planchas/Placas	Alta resistencia mecánica y a la corrosión. Alta soldadura. Buena confortabilidad.	Carrocería para autobuses y camiones, placas de señalización, industria naval, persianas, ojales, piezas estampadas con alta sollicitación mecánica, acero corrugados ferrocarriles, piso antideslizante, coberturas.
	Bobinas		
	Bloques		
5083	Planchas/Placas	Material con excelente aceptación para procesos de anodizado y soldadura, libre de tensiones internas.	Moldes termoplásticos – (inyección, soplado, RIM, ABS, PVC, PE, PU, entre otros); Moldes para automóviles; Moldes para calzado; Moldes agrícolas; Prototipos; Metal mecánico; Industria de guerra; Industria naval; Industria textil; Industria aeronáutica; Otros.
	Bloques		
5754	Planchas/Placas	Excelente resistencia a la corrosión, particularmente en entornos industriales. Tiene una resistencia mecánica razonable y buenas propiedades de anodización.	Industria naval y automotriz, equipos de pesca, industria alimentaria, estructuras soldadas, aplicaciones arquitectónicas.
	Chapa antideslizante		
6060	Barra redonda	Alta resistencia a la corrosión. Mediana resistencia mecánica. Buena confortabilidad. Apropiaada a la anodización decorativa mate.	Perfiles en general, tubos de irrigación, muebles, iluminación y adornos.
	Barras Planas		
	Tubos		
	Perfiles		

PRINCIPALES ALEACIONES, FORMATOS, CARACTERÍSTICAS Y APLICACIONES parte 3/5

Aleaciones	Formatos	Características	Aplicaciones
6061	Tubos	Alta resistencia mecánica y a la corrosión. Buena confortabilidad y soldadura.	Estructuras, construcción naval, vehículos, industria de muebles, rebites, acero corrugados, oleoductos.
	Barra redonda		
	Perfiles		
	Planchas/Placas		
6063	Barra redonda	Alta resistencia a la corrosión. Mediana resistencia mecánica. Buena confortabilidad. Apropiaada a la anodización decorativa mate.	Perfiles en general, tubos de irrigación, muebles, iluminación y adornos.
	Barras Planas		
	Tubos		
	Perfiles		
6082	Barras	Tiene una resistencia media a alta. Ofrece buena soldabilidad, brazabilidad, cierta resistencia a la corrosión, conformabilidad y maquinabilidad.	Tubería; Los grados; mueble; extruidos arquitectónicos; camión y camión de remolque; diapositivas; ventanas riego. Ingeniería estructural, construcción de barcos, vehículos y equipos, piezas mecanizadas en tornos automáticos, forja en frío. -Elementos sujetos a altas tensiones mecánicas -Estructuras de ingeniería -Construcción de barcos y vehículos -Dispositivos eléctricos -Industria eléctrica y requisitos de precisión.
	Tubos		
	Perfiles		
	Varillas		
6101	Barra redonda	Alta conductividad eléctrica. Buena resistencia a la corrosión. Mediana resistencia mecánica.	Conductores y embarrados eléctricos.
	Barras		
	Tubos		
	Perfiles		

PRINCIPALES ALEACIONES, FORMATOS, CARACTERÍSTICAS Y APLICACIONES **parte 4/5**

Aleaciones	Formatos	Características	Aplicaciones
6261	Barra redonda	Buena resistencia mecánica. Buena resistencia a la corrosión. Buena confortabilidad. Mediana industria.	Carrocerías de vehículos, estructuras y equipos.
	Tubos		
	Perfiles		
6262	Barra redonda	Optima industria. Alta resistencia mecánica. Alta resistencia a la corrosión. Apropiaada a anodización decorativa.	Piezas industria en torno automático.
	Perfiles		
6351	Barra redonda	Alta resistencia mecánica. Alta resistencia a la corrosión. Buena confortabilidad. Boa usinabilidad.	Ingeniería estructural, construcción de navíos, vehículos y equipos, piezas de usina en torno automático, forjado en frío.
	Tubos		

PRINCIPALES ALEACIONES, FORMATOS, CARACTERÍSTICAS Y APLICACIONES parte 5/5

Aleaciones	Formatos	Características	Aplicaciones
7021	Bloques	Tensiones internas extremadamente bajas. Buena estabilidad de forma. Alta resistencia. Buena homogeneidad.	Moldes termoplásticos – (injeção, sopro, RIM, TPU, PP, PE, entre otros), moldes automobilísticos, moldes calçadistas, moldes agrícolas, moldes protótipos, metal-mecânico, indústria bélica, indústria aeronáutica.
7028	Planchas/Placas	Resistencia a la corrosión. Buena industria. Buen pulido.	Piezas que requieren alto grado de industria, chapas de base o chapas para mesas de trabajo de todos los tipos, moldes de inyección termoplástica para prototipos, moldes de sopro, moldes para resinas fundidas, bloques de almacenaje y soporte resistentes a grandes impactos y carga, chasis para máquinas, máquinas selladoras de botellas (PET), moldes automobilísticos, moldes de calzados, moldes agrícolas, industrias bélicas, aeronáutica y otras.
	Bloques		
7075	Planchas/Placas	El más alto valor de resistencia mecánica; Mayor resistencia a la corrosión; Buena forja; Buena industria; Rigidez 150 a 180HB; El más alto valor de resistencia mecánica. Mediana resistencia a la corrosión. Buena forja. Buena industria. Rigidez 150 a 180HB. Rápida respuesta al pulido.	Piezas sujetas al más alto esfuerzo mecánico. Industria Militar, industria aeronáutica, máquinas y equipos, moldes para inyección de plástico, desarrollo de Herramientas.
	Barra redonda		
8011	Bobinas	Alta soldabilidad. Buena resistencia a la corrosión. Buena confortabilidad. Baja resistencia mecánica.	Envases de productos farmacéuticos, alimentares y flexibles en general, tapas, platos y bandejas desechables, aletas para refrigeración, tubos helicoidales.
	(Folhas)		
	Perfiles		

COMPOSICIÓN QUÍMICA DEL ALUMINIO

parte 1/3

Aleación	Al	Si	Fe	Cu	Mn	Mg	Cr	Zn	Ti	Otros	Otros
ABNT/ ASTM	(%)	(%)	(%)	(%)	(%)	(%)	(%)	(%)	(%)	Cada (%)	Total (%)
1050	99.50	0.25	0.40	0.05	0.05	0.05	-	0.05	0.03	0.03	-
	mín.										
1100	99.00	0,95 (Si+Fe)		0.05	0.05			0.10		0.05	0.15
	mín.			0.20							
1200	99.00	1,00 (Si+Fe)		0.05	0.05			0.10	0.05	0.05	0.15
	mín.										
1350	99.50	0.10	0.40	0.05	0.01		0.01	0.05		0.03	0.10
	mín.										
2011	restante	0.40	0.70	5.00				0.30		0.05	0.15
				6.00							
3003	restante	0.60	0.70	0.05	1.00			0.10		0.05	0.15
				0.20	1.50						
3104	restante	0.60	0.80	0.05	0.80	0.80		0.25	0.10	0.05	0.15
				0.25	1.40	1.30					

COMPOSICIÓN QUÍMICA DEL ALUMINIO

parte 2/3

Aleación	Al	Si	Fe	Cu	Mn	Mg	Cr	Zn	Ti	Otros	Otros
ABNT/ ASTM	(%)	(%)	(%)	(%)	(%)	(%)	(%)	(%)	(%)	Cada (%)	Total (%)
3105	restante	0.60	0.70	0.30	0.30	0.20	0.20	0.40	0.10	0.05	0.15
					0.80	0.80					
5052	Balanço	0,25	0,40	0,10	1,00	2,20-2,80	0,15-0,35	0,10	--	--	--
5083	Restante	0,40	0,40	0,10	1,00	4,90	0,25	0,25	0,15	--	--
5754	Restante	0,25	0,40	0,10	0,10	2,80	0,35	0,10	--	--	--
6061	restante	0.40	0.70	0.15	0.15	0.80	0.04	0.25	0.15	0.05	0.15
		0.80		0.40		1.20	0.35				
6063	restante	0.20	0.35	0.10	0.10	0.45	0.10	0.10	0.10	0.05	0.15
		0.60				0.90					
6082	Restante	1,30	0,50	0,10	1,00	1,20	0,25	0,20	0,10	--	--
6101	restante	0.30	0.50	0.10	0.03	0.35	0.03	0.10		0.03	0.10
		0.70				0.80					
6262	restante	0.40	0.70	0.15	0.15	0.80	0.04	0.25	0.15	0,05*	0,15*
		0.80		0.40		1.20	0.14				

COMPOSICIÓN QUÍMICA DEL ALUMINIO

parte 3/3

Aleación	Al	Si	Fe	Cu	Mn	Mg	Cr	Zn	Ti	Otros	Otros
ABNT/ ASTM	(%)	(%)	(%)	(%)	(%)	(%)	(%)	(%)	(%)	Cada (%)	Total (%)
6351	restante	0.70	0.50	0.10	0.40	0.40		0.20	0.20	0.05	0.15
		1.30			0.80	0.80					
7021	restante	0.25	0.40	0.25	0.10	1.20	0.05	5.00	0.10	0.05	0.15
							1.80				
7028	restante	0.35	0.50	0.10	0.15	1.50	0.20	4.50	0.05	0.05	0.15
						0.30	0.60				
7075	restante	-	0.35	1.20	0.20	2.10	0.18	5.10	0.30	0.05	0.15
		0.30					1.60				
8011	restante	0.50	0.60	0.10	0.20	0.05	0.05	0.10		0.05	0.15
		0.90	1.00								

* Bismuto (Bi) y Plomo (Pb) que van desde 0,4% a 0,7% cada uno, no incluidos en otros elementos.

Notas:

1. Los valores mencionados representan límites máximos por elemento químico, excepto cuando se indiquen intervalos entre el mínimo y el máximo.
2. Composición química equivalente a la norma ASTM B-221 (ABNT-NBR 6834).
3. Los valores indicados no implican garantía formal.

PROPIEDADES MECÁNICAS DEL ALUMINIO

parte 1/3

Aleación ABNT ASTM	DIN	Temple	Límite de Resistencia a la Tracción (N/mm ²)Mín.	Límite de Resistencia a la Tracción Mpa (N/mm ²)Máx.	Límite de Fluencia Mpa (N/mm ²)Mín.	Alargamiento Mínimo "50mm"(%)	Dureza Brinell (HB)
1050	Al 99,5	O	55	95	15	22	20
		H14	95	130	70	3	26
1100	-	O	75	105	25	22	23
		H14	110	145	95	3	32
1200	Al 99,0	O	75	105	25	22	23
		H14	110	145	95	3	32
1350	E-Al	O	55	95	-	22	20
		H14	95	130	-	3	30
2011	Al Cu Pb Bi	T4	275	-	125	16	-
		T8	370	-	275	10	100
3003	Al Mn Cu	O	95	130	35	22	28
		H14	140	180	115	3	40
3104	Al Mn	O	150	200	60	15	45
		H32	190	240	145	3	58
		H34	220	265	170	3	66

PROPIEDADES MECÁNICAS DEL ALUMINIO

parte 2/3

Aleación ABNT ASTM	DIN	Temple	Límite de Resistencia a la Tracción (N/mm ²)Mín.	Límite de Resistencia a la Tracción Mpa (N/mm ²)Máx.	Límite de Fluencia Mpa (N/mm ²)Mín.	Alargamiento Mínimo "50mm"(%)	Dureza Brinell (HB)
3105	Al Mn0,5 Mg0,5	O	95	145	35	19	28
		H14	150	200	125	2	40
5052	Al Mg2,5	O	170	215	65	17	47
		H34	235	285	180	4	68
5083	DIN (AlMg4,5Mn)	H111	285	--	135	10	70
		O	275	350	125	16	60
		F	280	360	125	--	68
5754	AlMg3	H111	190	260	80	10	55
6060	Al Mg Si0,5	T5	145	-	105	8	60
6061	Al Mg Si Cu	T4	180	-	110	16	65
		T6	260	-	240	8	95
6063	Al Mg Si0,5	T5	145	-	105	8	60
6082	--	T-6	300	--	255	--	90-110
6101	E-Al Mg Si0,5	T6	200	-	172	8	78
6262	-	T6	260	-	240	10	90

PROPIEDADES MECÁNICAS DEL ALUMINIO

parte 3/3

Aleación ABNT ASTM	DIN	Temple	Límite de Resistencia a la Tracción (N/mm ²)Mín.	Límite de Resistencia a la Tracción Mpa (N/mm ²)Máx.	Límite de Fluencia Mpa (N/mm ²)Mín.	Alargamiento Mínimo "50mm"(%)	Dureza Brinell (HB)
6351	Al Mg Si1,0	T6	290	-	255	10	95
7021	Al Zn5,5 Mg1,5	T6	350	380	310	2.5	110
7028	Al Zn5,5 Mg1,5		300	320	240	3	100
7075	Al Zn5,6 Mg2,5 Cu1,6 Fe0,35 Cr0,23 Mn0,20 Si0,30 Ti0,30	T651	480	540	390	4	150
8011	Al Fe Si	O	80	120	50	12	28
		H14/H24	120	210	110	4	35

Notas:

- Los valores indicados no darán lugar a garantía formal.
- Los datos de tensión se expresarán en la unidad megapascal (Mpa), equivalente a 1N/mm². Para obtener la medida de la unidad en kgf/mm², se divide el valor indicado por 9,807. Clasificación de las Temple:
 - O** - Recocido: Se aplica a productos acabados, en el estado en que presentan el menor valor de resistencia mecánica.
 - H** - Cruda: Se aplica a productos de aleaciones no tratables térmicamente, es decir, aleaciones donde el aumento de la resistencia mecánica se logra solo por deformación plástica a frío (encruamiento).
 - F** - Como Fabricada: Se aplica a los productos obtenidos a través de procesos de conformación en los que no se emplea ningún control especial sobre las condiciones térmicas o de enclavamiento. No se especifican límites para las propiedades mecánicas.
 - T** - Tratada Térmicamente: Se aplica a los productos que sufren tratamiento térmico con o sin deformación plástica complementaria, que produce propiedades físicas estables y diferentes de las obtenidas con "F", "O" y "H".
- Para las aleaciones con temple H114, utilizar los límites especificados en el temple "O".
- Para las aleaciones con temple H154, utilizar los límites especificados en el temple "H14".
- En el caso de los materiales laminados, los valores de alargamiento corresponderán a espesores de 0,63 a 1,20 m.
- Propiedades mecánicas según ABNT-NBR 7823 (laminados) y ABNT-NBR 7000:2005 (extrudados).

PROPIEDADES FÍSICAS DEL ALUMINIO

parte 1/2

Aleaciones ABNT/ASTM	Densidad a 20 °C (p=Peso Específico) (g/cm³)	Temperatura de Fusión (°C)	Calor Específico 0 a 100 °C (cal/g °C)	Coefficiente de Expansión Térmica 20° a 100 °C (10-6 °C)	Conductividad Térmica a 25 °C (cal/cm/cm²/seg °C)	Conductividad Eléctrica a 20 °C (% IACS)	Módulo de Elasticidad (MPA)	Módulo de Rigidez (MPA)
1050	2.7	650 - 660	0.22	24	0.50	60	70,000	26,500
1100	2.71	643 - 657	0.22	24	0.53	59	70,000	26,500
1350	2.7	650 - 660	0.22	23	0.54	62	70,000	26,500
2011	2.82	535 - 645	0.23	23	0.37	40	72,500	27,500
3003	2.73	640 - 655	0.22	23	0.38	43	70,000	26,500
3104	2.72	630 - 655	0.21	24	0.41	42	69,000	26,000
3105	2.71	635 - 654	0.22	24	0.41	45	70,000	26,500
5052	2.68	595 - 650	0.23	23	0.33	35	72,000	27,500
5083 - F	2,66	--	900	24	0,34	15-18	~ 70	--
5083 H111	2,66	--	900	24	0,34	15-18	~ 70	--
5083 - O	2,66	--	900	24	0,34	15-18	~ 70	--
5754	2,67	595°C	900	23,9	0,30	20-23	~ 70	--
6060	2.71	600 - 650	0.21	23	0.48	52	70,000	26,500

PROPIEDADES FÍSICAS DEL ALUMINIO

parte 2/2

Aleaciones ABNT/ASTM	Densidad a 20 °C (p=Peso Específico) (g/cm ³)	Temperatura de Fusión (°C)	Calor Específico 0 a 100 °C (cal/g °C)	Coefficiente de Expansión Térmica 20° a 100 °C (10 ⁻⁶ °C)	Conductividad Térmica a 25 °C (cal/cm/cm ² /seg °C)	Conductividad Eléctrica a 20 °C (% IACS)	Módulo de Elasticidad (MPA)	Módulo de Rigidez (MPA)
6061	2.71	580 - 650	0.22	24	0.37	43	70,000	26,500
6063	2.71	600 - 650	0.21	23	0.48	52	70,000	26,500
6082	2,7	--	896	23,4	0,38	24-32	~ 70	--
6101	2.71	605 - 655	0.22	23	0.49	55	70,000	26,500
6262	2.71	582 - 652	0.21	23	0.37	44	70,000	26,700
6351	2.71	555 - 650	0.21	24	0.44	46	70,000	26,500
7021	2.80	510 - 630	0.21	23	0.33	37	70,000	26,500
7028	2.77	510 - 630	0.21	23	0.33	37	70,000	26,500
7075	2.75	475 - 630	0.22	23	0.35	40	73,000	27,500

Notas: Los valores indicados no darán lugar a garantía formal.

CHAPA LISA PESO POR M²

parte 1/2

Pulgada	Milímetro	Línea 1000	Línea 5000	Línea 6000	Línea 7000	Pulgada	Milímetro	Línea 1000	Línea 5000	Línea 6000	Línea 7000
--	0,30	0,810	--	--	--	1/4"	6,35	---	17,145	--	17,780
--	0,40	1,080	--	--	--	5/16"	7,94	---	21,438	--	--
--	0,50	1,350	--	--	--	3/8"	9,53	---	25,731	--	26,684
--	0,60	1,620	--	--	--	1/2"	12,70	---	34,290	--	35,560
--	0,70	1,890	--	--	--	5/8"	15,87	---	42,849	--	44,436
--	0,80	2,160	--	--	--	3/4"	19,05	---	51,435	--	53,340
--	0,90	2,430	--	--	--	7/8"	22,22	---	59,994	--	62,216
--	1,00	2,700	2,700	--	--	1"	25,40	---	68,580	--	71,120
--	1,20	3,240	3,240	--	--	1.1/4"	31,75	---	85,725	--	88,900
--	1,50	4,050	4,050	--	--	1.1/2"	38,10	---	102,870	--	106,680
--	2,00	5,400	5,400	--	--	2"	50,80	---	137,160	--	142,240
--	2,50	2,700	2,700	--	--	2.1/4"	57,15	---	154,305	--	160,020
--	3,00	8,100	8,100	--	--	2.1/2"	63,50	---	171,450	--	177,800
1/8"	3,17	8,559	8,559	--	--	3"	76,20	---	205,740	--	213,360
--	4,00	10,800	10,800	--	--						
3/16"	4,76	12,852	12,852	--	--						

CHAPA LISA PESO POR M²

Pulgada	Milímetro	Línea 1000	Línea 5000	Línea 6000	Línea 7000
3.1/2"	88,90	---	240,030	--	248,920
4"	101,60	---	274,320	--	284,480
5"	127,00	---	342,900	--	355,600
6"	152,40	---	411,480	--	426,720
---	260,00	---	702,000	704,600	728,000
---	300,00	---	810,000	813,000	840,000

CHAPA STUCCO PESO/PIEZA

Espesor de la base (mm)	Metro ²	2000x1000mm	2000x1100mm	3000x1250mm
0,40	1,080	2,160	2,376	4,050
0,50	1,350	2,700	2,970	5,063
0,70	1,890	3,780	4,158	7,088
0,80	2,160	4,320	4,752	8,100
1,00	2,700	5,400	5,940	10,125
1,20	3,240	6,480	7,128	12,150

aluminio

CHAPA AJEDREZ - PESO/PIEZA

Espesor de la base (mm)	Altura de los salientes	M²	2500 X 1000mm	3000 X 1000mm	3000 X 1250mm
1,00	0,50 a 1,30	3,880	9,700	11,640	14,550
1,20	0,50 a 1,30	4,600	11,500	13,800	17,250
1,50	0,50 a 1,30	5,320	13,300	15,960	19,950
1,80	0,50 a 1,30	6,160	15,400	18,480	23,100
2,00	0,50 a 1,30	6,800	17,000	20,400	25,500
2,20	0,50 a 1,30	7,200	18,000	21,600	27,000
2,70	0,50 a 1,30	8,400	21,000	25,200	31,500

ACERO CORRUGADO PESO/METRO

parte 1/3

Pulgada	Milímetro			
1/4"	6,35	0,086	0,109	0,095
5/16"	7,94	0,134	0,171	---
3/8"	9,53	0,193	0,246	0,213
7/16"	11,11	0,263	0,335	0,290
1/2"	12,70	0,343	0,437	0,379
9/16"	14,28	0,434	---	0,479
5/8"	15,87	0,536	0,683	0,591
11/16"	17,46	0,649	---	---
3/4"	19,05	0,772	0,983	0,852
7/8"	22,22	1,051	1,338	1,159
1"	25,40	1,373	1,748	1,514
1.1/16"	26,97	1,548	---	1,707
1.1/8"	28,57	1,737	---	1,916
1.1/4"	31,75	2,146	2,732	2,366
1.3/8"	34,92	2,595	3,305	2,862
1.1/2"	38,10	3,090	3,934	3,407
1.5/8"	41,27	3,625	4,616	3,997

ACERO CORRUGADO PESO/METRO

Pulgada	Milímetro	●	■	⬡
1.3/4"	44,45	4,205	5,354	4,637
1.7/8"	47,62	4,827	---	5,322
2"	50,80	5,493	6,994	6,056
2.1/8"	53,97	6,200	---	---
2.1/4"	57,15	6,952	8,851	---
2.1/2"	63,50	8,582	10,927	9,463
2.3/4"	69,85	10,385	---	---
3"	76,20	12,359	15,735	---
3.1/4"	82,55	14,504	---	---
3.1/2"	88,90	16,821	21,418	---
4"	101,60	21,971	27,974	---
4.1/2"	114,30	27,807	---	---
5"	127,00	34,330	---	---
5.1/2"	139,70	41,539	---	---
6"	152,40	49,434	---	---
6.1/2"	165,10	58,017	---	---
7"	177,80	67,286	---	---

bronce

Bronce

El bronce es una aleación metálica versátil y tiene base en el cobre y proporciones variables de otros elementos como estaño (Sn), Zinc (Zn), chumbo (Pb) y fósforo (P). Algunas de sus características son:

- ▶ Alta resistencia mecánica;
- ▶ Alta ductilidad;
- ▶ Alta resistencia al desgaste;
- ▶ Alta resistencia a la corrosión.

Uno de los factores que vuelve esa materia-prima tan esencial para la industria es la alta resistencia al desgaste por fricción, por ello el bronce es un material muy usado en cojinetes, engranajes y piezas relacionadas.

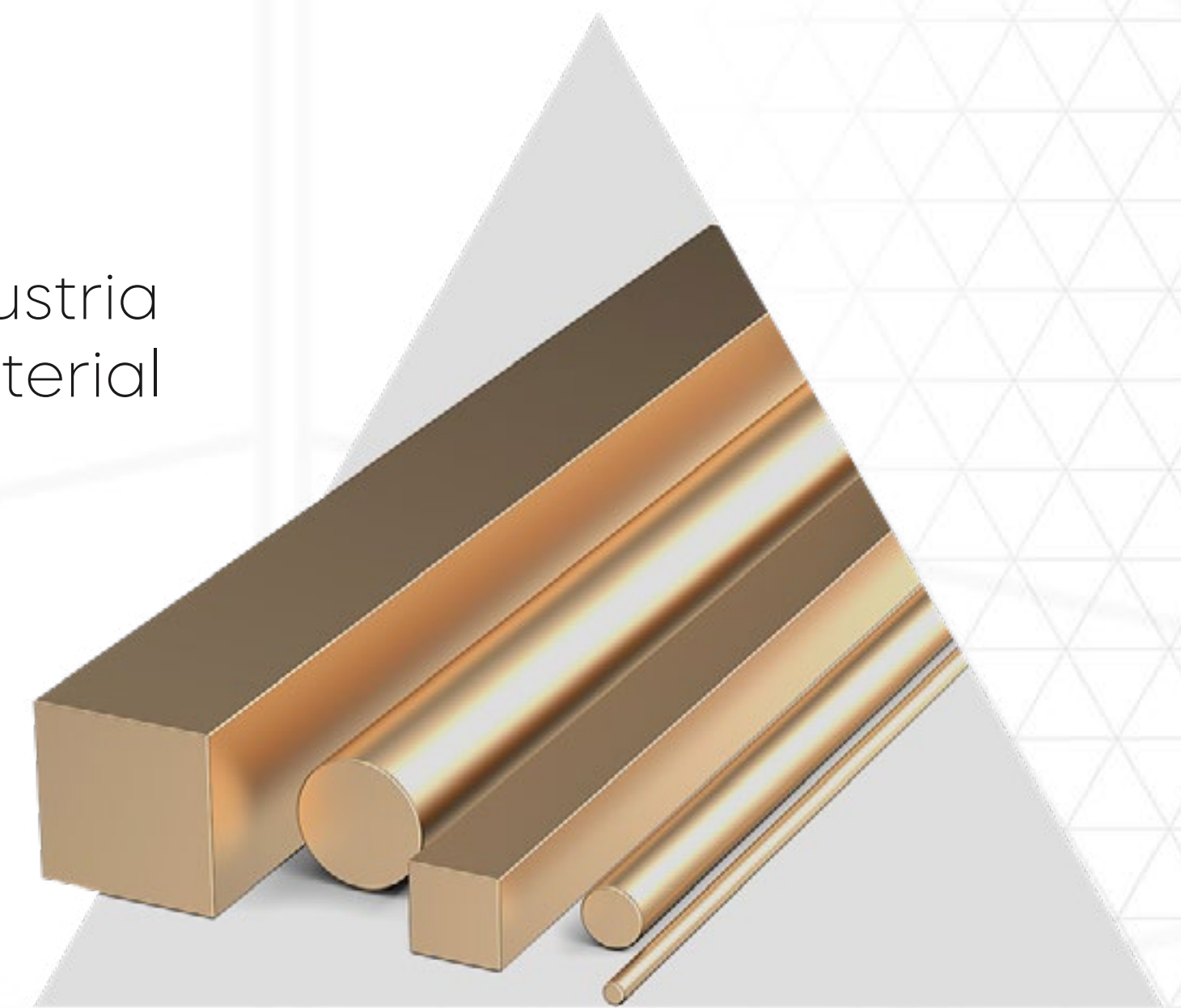

Denominación	Aleaciones ASTM/UNS	Formato	Características	Aplicaciones
Bronce Fosforoso	C51000	Bobinas, plancha/placa, Tiras	Excelente confortabilidad a frio y limitada confortabilidad a caliente. Excelente soldadura y brazaje.	Hélices de agitadores, fuelles, discos de fricción, chavetas, diafragmas, tuercas y rebites, arandelas de presión, componentes para industrias Químicas, Textil y de Papel, Muelles, contactos, piezas, para interruptores, soporte de fusibles.
Bronce Fosforoso	C51100	Bobinas, plancha/placa, Tiras	Excelente conformabilidad a frio y mala confortabilidad a caliente. Excelente soldadura y brazaje.	Sinos, discos de engranaje, chavetas, diafragmas tirantes, muelles, partes de interruptores, terminales.
Bronce Fosforoso	C52100	Bobinas, plancha/placa, Tiras	Excelente confortabilidad a frio y mala confortabilidad a caliente. Excelente soldadura y brazaje.	Hélices de agitadores, fuelles, discos de fricción, chavetas, diafragmas, tuercas y rebites, arandelas de presión, componentes para industrias Químicas, Textil y de Papel, Muelles, contactos, piezas, para interruptores, soporte de fusibles.
Bronce SAE 65 Bz 12 Bz 14 CuSn	C90700 C90800 C91000	Bujes, barras, Barras Rectangulares	Rigidez tenaz con buena resistencia al desgaste a la corrosión y a la fatiga superficial. Permite trabajar con cargas específicas elevadas. Importante estar bien lubricada.	Engranajes, bujes, cojinetes, coronas guías deslizantes, anillos de pistón.
Bronce SAE 62 SAE 620 SAE 622 CuSnZn	C90500 C90300 C92200	Bujes, barras, Barras Rectangulares	Resistente a la corrosión y al agua del mar. Permite trabajar con cargas específicas medianas.	Anillos de sellado, válvulas, sede de hastíes, franges y conexiones, carcasa y rotores de bombas, piezas resistentes a la presión y a la temperatura.

PRINCIPALES ALEACIONES, FORMATOS, CARACTERÍSTICAS Y APLICACIONES parte 2/3

Denominación	Aleaciones ASTM/UNS	Formato	Características	Aplicaciones
Bronce SAE 64 SAE 66 SAE 67 CuSnPb	C93700 C93500 C93800	Bujes, barras, Barras Rectangulares	Excelente resistencia a la abrasión, corrosión, antifricción y estanques de presión. Buena capacidad de trabajar precariamente sin lubricación momentánea.	Bujes para prensa, zapatas, cojinetes, bujes para pino de émbolos, casquillos de deslice.
Bronce SAE 40 SAE 660 CuSnPbZn	C83600 C93200	Bujes, barras, Barras Rectangulares	Buenas propiedades de antifricción y resistencias medianas. Utilizar en piezas que requieren velocidad y presión superficial moderada.	Piezas pequeñas como cojinetes, bujes, casquillos, coronas, anillo, material hidráulico y guarniciones, elementos de acoplamiento.
Bronce SAE 68-A SAE 68-B SAE CA-624 SAE CA-630 SAE CA-954 SAE CA-955 CuAl	C95200 C95300 C62400 C63000 C95400 C95500	Bujes, barras, Barras Rectangulares	Excelentes propiedades mecánicas. Resistente a vibraciones, desgastes, corrosión y cavitación. Tratables térmicamente, exigen buena lubricación.	Cojinetes deslizantes con carga y choques extremadamente altas, coronas altamente solicitadas, bujes, engranajes, asiento y sede de válvulas, guías, piñones, anillos, zapatas, piezas para agitadores y herramientas
Bronce SAE 430-A SAE 430-B SAE 43 CuZnAlMn	C86200 C86300 C86500	Bujes, barras, Barras Rectangulares	Excelente Resistencia a la Corrosión y excelentes propiedades de soportar cargas estáticas extremadamente altas y bajas velocidades.	Indicadas para cojinetes y coronas muy solicitadas y componentes internos de válvulas de alta presión, bujes, tuercas para prensas, piezas para cilindros hidráulicos, componentes de puentes escaleras, soportes de alta resistencia.

bronce

PRINCIPALES ALEACIONES, FORMATOS, CARACTERÍSTICAS Y APLICACIONES **parte 3/3**

Denominación	Aleaciones ASTM/UNS	Formato	Características	Aplicaciones
Bronce TM-23		Bujes, barras	Buena confortabilidad y resistencia a la fatiga. Mediana resistencia a la corrosión. Excelente soldadura. Permite trabajar en sistemas con lubricación precaria.	Cojinetes, bujes, casquillos para industrias automotoras, surco alcoholera y de máquinas pesadas, válvulas.
Bronce TM-620		Bujes, barras	Buena resistencia a la fatiga. Permite trabajar con cargas específicas elevadas. Se debe trabajar en sistemas con lubricación constante.	Buena resistencia a la fatiga. Permite trabajar con cargas específicas elevadas. Se debe trabajar en sistemas con lubricación constante.

bronce

COMPOSICIÓN QUÍMICA DEL BRONCE

parte 1/4

Denominación	Aleaciones	Cu	Zn	Pb	P	Sn	Fe	Al	Ni	Mn	Si	Outros
	ASTM / UNS	(%)	(%)	(%)	(%)	(%)	(%)	(%)	(%)	(%)	(%)	(%)
Bronce Fosforoso	C51000	restante	0.30	0.05	0.03	4.20	0.10					
					0.35	5.80						
Bronce Fosforoso	C51100	restante	0.30	0.05	0.03	3.50	0.10					
					0.35	4.90						
Bronce Fosforoso	C52100	restante	0.20	0.05	0.03	7.00	0.10					
					0.35	9.00						
Bronce SAE 65	C90700	88.00		0.5	0.30	10.00		0.005	0.500		0.005	0.3
CuSn		90.00				12.00						
Bronce Bz 12	C90800	84.00	0.25	0.25	0.15	11.00	0.15		0.500			Sb=0,20
CuSn		88.00				13.00						
Bronce Bz 14	C91000	85.00	0.50	1.00	0.20	13.00	0.20		1.000			
CuSn		87.00				14.00						
Bronce SAE 62	C90500	86.00	1.00	0.3	0.05	9.00	0.15	0.005	1.000		0.005	0.3
CuSnZn		89.00				11.00						

bronce

COMPOSICIÓN QUÍMICA DEL BRONCE

parte 2/4

Denominación	Aleaciones	Cu	Zn	Pb	P	Sn	Fe	Al	Ni	Mn	Si	Outros
	ASTM / UNS	(%)	(%)	(%)	(%)	(%)	(%)	(%)	(%)	(%)	(%)	(%)
Bronce SAE 622	C92200	86.00	3.00	1.00	0.05	5.50	0.30	0.005	1.000		0.005	0.3
CuSnZn		90.00	5.00	2.00		6.50						
Bronce SAE 64	C93700	78.00	0.80	8.00	0.50	9.00	0.15	0.005	1.000		0.005	Sb=0,60
CuSnPb		82.00		11.00		11.00						out-ros=0,20
Bronce SAE 66	C93500	83.00	2.00	8.00	0.05	4.50	0.20	0.005	0.800		0.005	Sb=0,35
CuSnPb		86.00		10.00		6.00						out-ros=0,30
Bronce SAE 67	C93800	75.00	0.80	13.00	0.05	6.30	0.15	0.005	0.800		0.005	Sb=0,80
CuSnPb		79.00		16.00		7.50						out-ros=0,20
Bronce SAE 40	C83600	84.00	4.00	4.00	0.05	4.00	0.30	0.005	1.000		0.005	0.35
CuSnPbZn		86.00	6.00	6.00		6.00						
Bronce SAE 660	C93200	81.00	2.00	6.00	0.50	6.20	0.20	0.005	0.800		0.005	Sb=0,35
CuSnPbZn		85.00	4.00	8.00		7.50						out-ros=0,20

bronce

COMPOSICIÓN QUÍMICA DEL BRONCE

parte 3/4

Denominación	Aleaciones	Cu	Zn	Pb	P	Sn	Fe	Al	Ni	Mn	Si	Outros
	ASTM / UNS	(%)	(%)	(%)	(%)	(%)	(%)	(%)	(%)	(%)	(%)	(%)
Bronce SAE 68-A	C95200	86.00					2.50	8.50				1.00
CuAl		(mín.)					4.00	9.50				
Bronce SAE 68-B	C95300	86					0.70	9.00				1.00
CuAl		(mín.)					1.50	11.00				
Bronce SAE CA-624	C62400	99.5				0.20	2.00	10.00		0.30	0.250	
CuAl		(mín.)					4.00	11.50				
Bronce SAE CA-630	C63000	78.00				0.20	2.00	9.00	4.000	1.50	0.250	0.50
CuAl		85.00					4.00	11.00	5.500			
Bronce SAE CA-954	C95400	83.00					3.00	10.00	2.500	0.50		0.50
CuAl		(mín.)					5.00	11.50				
Bronce SAE CA-955	C95500	78.00					3.00	10.00	3.000	3.50		0.50
CuAl		(mín.)					5.00	11.50	5.500			
Bronce SAE 430-A	C86200	60.00	restante	0.20		0.20	2.00	3.00	1.000	2.50		0.30
CuZnAlMn		66.00								4.00		

bronce

COMPOSICIÓN QUÍMICA DEL BRONCE

parte 4/4

Denominación	Aleaciones	Cu	Zn	Pb	P	Sn	Fe	Al	Ni	Mn	Si	Outros
	ASTM / UNS	(%)	(%)	(%)	(%)	(%)	(%)	(%)	(%)	(%)	(%)	(%)
Bronce SAE 430-A	C86200	60.00	restante	0.20		0.20	2.00	3.00	1.000	2.50		0.30
CuZnAlMn		66.00					4.00	4.90		5.00		
Bronce SAE 430-B	C86300	60.00	restante	0.20		0.20	2.00	5.00	1.000	2.50		0.30
CuZnAlMn		66.00					4.00	7.50		5.00		
Bronce SAE 43	C86500	55.00	restante	0.40		1.00	0.40	0.50	1.000	1.50		0.30
CuZnAlMn		60.00					2.00	1.50				
Bronce TM-23	-	70.00	9.00	20.00		4.00						
		(mín.)	(máx.)	(máx.)		(mín.)						
Bronce TM-620	-	86.00	5.00	1.00		7.00						
		(mín.)	(máx.)	(máx.)		(mín.)						

Notas:

1. Los valores mencionados representan límites máximos por elemento químico, salvo si se indican intervalos entre mínimo y máximo.
2. Los valores indicados no darán lugar a garantía formal.

bronce

PROPIEDADES MECÁNICAS DEL BRONCE

parte 1/5

Denominación	Aleaciones ASTM/UNS	Formato	Temple	Límite de Resistencia a la Tracción (kgf/mm ²)	Límite de Fluencia (kgf/mm ²)	Alargamiento Mínimo "50,80 mm" (%)	Dureza Brinell (HB)
Bronce Fosforoso	C51000	Bobinas,	Duro	58	53	10	150
		placas/planchas, tiras	Extra Duro	67	56	6	164
Bronce Fosforoso	C51100	Bobinas,	Duro	56	52	7	142
		placas/planchas, tiras	Extra Duro	65	-	4	156
Bronce Fosforoso	C52100	Bobinas,	Duro	65	51	10	166
		placas/planchas, tiras	Extra Duro	73	56	4	172
Bronce SAE 65	C90700	Bujes,	-	25	13	10	95
		barra, barras rectangulares					
Bronce Bz 12	C90800	Bujes,	-	32	17	15	100
		barra, barras rectangulares					
Bronce Bz 14	C91000	Bujes,	-	25	17	5	110
		barra, barras rectangulares					

bronce

PROPIEDADES MECÁNICAS DEL BRONCE

parte 2/5

Denominación	Aleaciones ASTM/UNS	Formato	Temple	Límite de Resistencia a la Tracción (kgf/mm ²)	Límite de Fluencia (kgf/mm ²)	Alargamiento Mínimo "50,80 mm" (%)	Dureza Brinell (HB)
Bronce SAE 62	C90500	Bujes,	-	28	13	20	90
		barra, barras rectangulares					
Bronce SAE 620	C90300	Bujes,	-	28	13	20	70
		barra, barras rectangulares					
Bronce SAE 622	C92200	Bujes,	-	23	10	24	65
		barra, barras rectangulares					
Bronce SAE 64	C93700	Bujes,	-	21	8	15	82
		barra, barras rectangulares					
Bronce SAE 66	C93500	Bujes,	-	19	8	15	60
		barra, barras rectangulares					

Denominación	Aleaciones ASTM/UNS	Formato	Temple	Límite de Resistencia a la Tracción (kgf/mm ²)	Límite de Fluencia (kgf/mm ²)	Alargamiento Mínimo "50,80 mm" (%)	Dureza Brinell (HB)
Bronce SAE 67	C93800	Bujes,	-	18	9	12	50
		barra, barras rectangulares					
Bronce SAE 40	C83600	Bujes,	-	21	10	20	70
		barra, barras rectangulares					
Bronce SAE 660	C93200	Bujes,	-	21	10	12	75
		barra, barras rectangulares					
Bronce SAE 68-A	C95200	Bujes,	-	46	18	20	120
		barra, barras rectangulares					
Bronce SAE 68-B	C95300	Bujes,	-	46	18	20	130
		barra, barras rectangulares					

PROPIEDADES MECÁNICAS DEL BRONCE

parte 4/5

Denominación	Aleaciones ASTM/UNS	Formato	Temple	Límite de Resistencia a la Tracción (kgf/mm ²)	Límite de Fluencia (kgf/mm ²)	Alargamiento Mínimo "50,80 mm" (%)	Dureza Brinell (HB)
Bronce SAE CA-624	C62400	Bujes,	-	56	32	7	164
		barra, barras rectangulares					
Bronce SAE CA-630	C63000	Bujes,	-	63	32	6	228
		barra, barras rectangulares					
Bronce SAE CA-954	C95400	Bujes,	-	53	21	12	165
		barra, barras rectangulares					
Bronce SAE CA-955	C95500	Bujes,	-	63	28	6	190
		barra, barras rectangulares					
Bronce SAE 430-A	C86200	Bujes,	-	63	31	18	150
		barra, barras rectangulares					

PROPIEDADES MECÁNICAS DEL BRONCE

parte 5/5

Denominación	Aleaciones ASTM/UNS	Formato	Temple	Límite de Resistencia a la Tracción (kgf/mm ²)	Límite de Fluencia (kgf/mm ²)	Alargamiento Mínimo "50,80 mm" (%)	Dureza Brinell (HB)
Bronce SAE 430-B	C86300	Bujes,	-	77	42	12	200
		barra, barras rectangulares					
Bronce SAE 43	C86500	Bujes,	-	45	17	20	98
		barra, barras rectangulares					
Bronce TM-23	-	Tarugos, Bujes	-	28	16	23	75
Bronce TM-620	-	Tarugos, Bujes	-	36	17	32	92

Notas: Los valores indicados no darán lugar a garantía formal.

PROPIEDADES FÍSICAS DEL BRONCE

Denominación	Aleaciones ASTM/UNS	Densidad a 20 °C p=peso específico (g/cm ³)	Punto de Fusión (°C)	Conductividad Térmica a 20 °C (cal/cm/cm ² /seg °C)	Calor Específico a 20 °C (cal/g °C)	Resistividad Eléctrica a 20 °C (material recocido) (μ/cm)	Conductividad Eléctrica a 20 °C (material recocido) (%IACS)	Coefficiente de Expansión Térmica 20 a 300 °C (10 ⁻⁶ °C)	Módulo de Elasticidad a 20 °C (kg/mm ²)	Módulo de Rigidez a 20 °C (kg/mm ²)
Bronce Fosforoso	C51000	8.86	1,050	0.17	0.09	11.5	15	17.8	11,200	4,200
Bronce Fosforoso	C51100	8.86	1,060	0.2	0.09	8.7	20	17.8	11,200	4,200
Bronce Fosforoso	C52100	8.8	1,020	0.15	0.09	13.3	13	18.2	11,200	4,200

Notas: Los valores indicados no darán lugar a garantía formal.

PALANQUILLAS - PESO POR PIEZA CON 500 MM

Diámetro	Peso	Diámetro	Peso	Diámetro	Peso	Diámetro	Peso	Diámetro	Peso
3/8"	0,44	2.1/8"	10,91	4.1/8"	39,97	6.1/8"	87,28	8.1/8"	1473,66
7/16"	0,57	2.1/4"	12,19	4.1/4"	42,40	6.1/4"	90,85	8.1/4"	157,54
1/2"	0,72	2.3/8"	13,54	4.3/8"	44,90	6.3/8"	94,49	8.3/8"	162,33
9/16"	0,89	2.1/2"	14,97	4.1/2"	47,46	6.1/2"	98,19	8.1/2"	167,16
5/8"	1,08	2.5/8"	16,46	4.5/8"	50,09	6.5/8"	101,96	8.5/8"	172,07
3/4"	1,50	2.3/4"	18,03	4.3/4"	52,80	6.3/4"	105,81	8.3/4"	177,07
7/8"	2,00	2.7/8"	19,67	4.7/8"	55,58	6.7/8"	109,73	8.7/8"	182,12
1"	2,57	3"	21,38	5"	58,43	7"	113,72	9"	187,26
1.1/8"	3,21	3.1/8"	23,17	5.1/8"	61,35	7.1/8"	117,78	9.1/8"	192,45
1.1/4"	3,93	3.1/4"	25,02	5.1/4"	64,35	7.1/4"	121,92	9.1/4"	197,73
1.3/8"	4,71	3.3/8"	26,97	5.3/8"	67,41	7.3/8"	126,13	9.3/8"	203,08
1.1/2"	5,56	3.1/2"	28,93	5.1/2"	70,54	7.1/2"	130,40	9.1/2"	208,49
1.5/8"	6,49	3.5/8"	31,00	5.5/8"	73,75	7.5/8"	134,74	9.5/8"	213,97
1.3/4"	7,49	3.3/4"	33,14	5.3/4"	77,03	7.3/4"	139,16	9.3/4"	219,54
1.7/8"	8,56	3.7/8"	35,35	5.7/8"	80,37	7.7/8"	143,64	9.7/8"	225,16
2"	9,70	4"	37,63	6"	83,80	8"	148,21	10"	230,86

PALANQUILLAS - PESO POR PIEZA CON 500 MM

Diámetro	Peso	Diámetro	Peso	Diámetro	Peso	Diámetro	Peso
10.1/8"	236,63	12.1/8"	338,66	12.1/8"	338,66	15.1/4"	534,62
10.1/4"	248,38	12.1/4"	345,65	12.1/4"	345,65	15.1/2"	552,22
10.3/8"	248,40	12.3/8"	367,04	12.3/8"	367,04	15.3/4"	570,11
10.1/2"	36813,20	12.1/2"	359,83	12.1/2"	359,83	16"	588,28
10.5/8"	260,43	12.5/8"	367,02	12.5/8"	367,02	16.1/4"	606,73
10.3/4"	266,56	12.3/4"	374,30	12.3/4"	374,30	16.1/2"	625,47
10.7/8"	272,75	12.7/8"	381,63	12.7/8"	381,63	16.3/4"	644,50
11"	279,03	13"	389,05	13"	389,05	17"	663,81
11.1/8"	285,36	13.1/4"	404,08	13.1/4"	404,08	17.1/2"	703,28
11.1/4"	291,79	13.1/2"	419,40	13.1/2"	419,40	18"	743,90
11.3/8"	298,28	13.3/4"	435,01	13.3/4"	435,01	18.1/2"	785,65
11.1/2"	304,83	14"	451,12	14"	451,12	19"	828,55
11.5/8"	311,44	14.1/4"	467,07	14.1/4"	467,07	19.1/2"	872,58
11.3/4"	318,15	14.1/2"	483,53	14.1/2"	483,53	20"	917,76
11.7/8"	324,91	14.3/4"	500,28	14.3/4"	500,28	21"	1011,53
12"	331,76	15"	517,31	15"	517,31	22"	1109,86

BUJES - PESO POR PIEZA CON 500 MM

Diámetro externo	Diámetro interno	Peso	Diámetro externo	Diámetro interno	Peso	Diámetro externo	Diámetro interno	Peso	Diámetro externo	Diámetro interno	Peso
7/8"	1/2"	1,56	1.3/8"	5/8"	3,99	1.5/8"	7/8"	4,98	1.7/8"	5/8"	7,83
7/8"	5/8"	1,28	1.3/8"	3/4"	3,63	1.5/8"	1"	4,48	1.7/8"	3/4"	7,48
1"	1/2"	2,14	1.3/8"	7/8"	3,20	1.5/8"	1.1/8"	3,91	1.7/8"	7/8"	7,05
1"	5/8"	1,85	1.3/8"	1"	2,70	1.5/8"	1.1/4"	3,27	1.7/8"	1"	6,55
1"	3/4"	1,49	1.3/8"	1.1/8"	2,13	1.5/8"	1.3/8"	2,56	1.7/8"	1.1/8"	5,98
1.1/8"	1/2"	2,78	1.1/2"	1/2"	5,13	1.3/4"	1/2"	7,05	1.7/8"	1.1/4"	5,34
1.1/8"	5/8"	2,49	1.1/2"	5/8"	4,84	1.3/4"	5/8"	6,77	1.7/8"	1.3/8"	4,63
1.1/8"	3/4"	2,13	1.1/2"	3/4"	4,49	1.3/4"	3/4"	6,41	1.7/8"	1.1/2"	3,84
1.1/8"	7/8"	1,71	1.1/2"	7/8"	4,06	1.3/4"	7/8"	5,98	1.7/8"	1.5/8"	2,99
1.1/4"	1/2"	3,49	1.1/2"	1"	3,56	1.3/4"	1"	5,48	2"	1/2"	9,26
1.1/4"	5/8"	3,20	1.1/2"	1.1/8"	2,99	1.3/4"	1.1/8"	4,91	2"	5/8"	8,97
1.1/4"	3/4"	2,85	1.1/2"	1.1/4"	2,35	1.3/4"	1.1/4"	4,27	2"	3/4"	8,62
1.1/4"	7/8"	2,42	1.5/8"	1/2"	6,05	1.3/4"	1.3/8"	3,56	2"	7/8"	8,19
1.1/4"	1"	1,92	1.5/8"	5/8"	5,77	1.3/4"	1.1/2"	2,77	2"	1"	7,69
1.3/8"	1/2"	4,27	1.5/8"	3/4"	5,41	1.7/8"	1/2"	8,12	2"	1.1/8"	7,12

BUJES - PESO POR PIEZA CON 500 MM

Diámetro externo	Diámetro interno	Peso	Diámetro externo	Diámetro interno	Peso	Diámetro externo	Diámetro interno	Peso	Diámetro externo	Diámetro interno	Peso
2"	1.1/4"	6,48	2.1/8"	1.3/4"	4,41	2.3/8"	3/4"	12,46	2.1/2"	1"	12,96
2"	1.3/8"	5,77	2.1/4"	1/2"	11,75	2.3/8"	7/8"	12,04	2.1/2"	1.1/8"	12,39
2"	1.1/2"	4,98	2.1/4"	5/8"	11,47	2.3/8"	1"	11,54	2.1/2"	1.1/4"	11,75
2"	1.5/8"	4,13	2.1/4"	3/4"	11, 11	2.3/8"	1.1/8"	10,97	2.1/2"	1.3/8"	11,04
2"	1.3/4"	3,20	2.1/4"	7/8"	10,68	2.3/8"	1.1/4"	10,32	2.1/2"	1.1/2"	10,25
2.1/8"	1/2"	10,47	2.1/4"	1"	10, 18	2.3/8"	1.3/8"	9,61	2.1/2"	1.5/8"	9,40
2.1/8"	5/8"	10, 18	2.1/4"	1.1/8"	9,62	2.3/8"	1.1/2"	8,83	2.1/2"	1.3/4"	8,47
2.1/8"	3/4"	9,83	2.1/4"	1.1/4"	8,97	2.3/8"	1.5/8"	7,97	2.1/2"	1.7/8"	7,48
2.1/8"	7/8"	9,40	2.1/4"	1.3/8"	8,26	2.3/8"	1.3/4"	7,05	2.1/2"	2"	5,27
2.1/8"	1"	8,90	2.1/4"	1.1/2"	7,48	2.3/8"	1.7/8"	6,05	2.1/2"	2.1/8"	16,02
2.1/8"	1.1/8"	8,33	2.1/4"	1.5/8"	6,62	2.3/8"	2"	4,98	2.5/8"	1/2"	15,74
2.1/8"	1.1/4"	7,69	2.1/4"	1.3/4"	5,69	2.1/2"	1/2"	14,53	2.5/8"	5/8"	15,38
2.1/8"	1.3/8"	6,98	2.1/4"	1.7/8"	4,70	2.1/2"	5/8"	14,25	2.5/8"	3/4"	14,96
2.1/8"	1.1/2"	6,19	2.3/8"	1/2"	13, 10	2.1/2"	3/4"	13,89	2.5/8"	7/8"	14,46
2.1/8"	1.5/8"	5,34	2.3/8"	5/8"	12,82	2.1/2"	7/8"	13,46	2.5/8"	1"	13,46

BUJES - PESO POR PIEZA CON 500 MM

Diámetro externo	Diámetro interno	Peso
2.5/8"	1.1/8"	13,89
2.5/8"	1.1/4"	13,24
2.5/8"	1.3/8"	12,53
2.5/8"	1.1/2"	11,75
2.5/8"	1.5/8"	10,89
2.5/8"	1.3/4"	9,97
2.5/8"	1.7/8"	8,97
2.5/8"	2"	7,90
2.5/8"	2.1/8"	6,76
2.5/8"	2.1/4"	5,55
2.3/4"	1/2"	17,59
2.3/4"	5/8"	17,31
2.3/4"	3/4"	16,95
2.3/4"	7/8"	16,53
2.3/4"	1"	16,03

Diámetro externo	Diámetro interno	Peso
2.3/4"	1.1/8"	15,46
2.3/4"	1.1/4"	14,81
2.3/4"	1.3/8"	14,10
2.3/4"	1.1/2"	13,32
2.3/4"	1.5/8"	12,46
2.3/4"	1.3/4"	11,54
2.3/4"	1.7/8"	10,54
2.3/4"	2"	9,47
2.3/4"	2.1/8"	8,33
2.3/4"	2.1/4"	7,12
2.3/4"	2.3/8"	5,84
2.7/8"	1/2"	19,23
2.7/8"	5/8"	18,95
2.7/8"	3/4"	18,59
2.7/8"	7/8"	18,16

Diámetro externo	Diámetro interno	Peso
2.7/8"	1"	17,66
2.7/8"	1.1/8"	17,09
2.7/8"	1.1/4"	16,45
2.7/8"	1.3/8"	15,74
2.7/8"	1.1/2"	14,95
2.7/8"	1.5/8"	14,10
2.7/8"	1.3/4"	13,17
2.7/8"	1.7/8"	12,18
2.7/8"	2"	11,11
2.7/8"	2.1/8"	9,97
2.7/8"	2.1/4"	8,75
2.7/8"	2.3/8"	7,47
2.7/8"	2.1/2"	6,12
3"	1/2"	20,94
3"	5/8"	20,66

Diámetro externo	Diámetro interno	Peso
3"	3/4"	20,30
3"	7/8"	19,87
3"	1"	19,37
3"	1.1/8"	18,81
3"	1.1/4"	18,16
3"	1.3/8"	17,45
3"	1.1/2"	16,66
3"	1.5/8"	15,81
3"	1.3/4"	14,88
3"	1.7/8"	13,89
3"	2"	12,82
3"	2.1/8"	11,68
3"	2.1/4"	10,46
3"	2.3/8"	9,18
3"	2.1/2"	7,83

BUJES - PESO POR PIEZA CON 500 MM

Diámetro externo	Diámetro interno	Peso	Diámetro externo	Diámetro interno	Peso	Diámetro externo	Diámetro interno	Peso	Diámetro externo	Diámetro interno	Peso
3"	2.5/8"	6,41	3.1/8"	2.1/4"	12,25	3.1/4"	1.7/8"	17,52	3.3/8"	1.3/8"	23,04
3.1/8"	1/2"	22,72	3.1/8"	2.3/8"	10,97	3.1/4"	2"	16,45	3.3/8"	1.1/2"	22,25
3.1/8"	5/8"	22,44	3.1/8"	2.1/2"	9,61	3.1/4"	2.1/8"	15,31	3.3/8"	1.5/8"	21,40
3.1/8"	3/4"	22,08	3.1/8"	2.5/8"	8,19	3.1/4"	2.1/4"	14,10	3.3/8"	1.3/4"	20,48
3.1/8"	7/8"	21,65	3.1/4"	1/2"	24,57	3.1/4"	2.3/8"	12,82	3.3/8"	1.7/8"	19,48
3.1/8"	1"	21,15	3.1/4"	5/8"	24,29	3.1/4"	2.1/2"	11,46	3.3/8"	2"	18,41
3.1/8"	1.1/8"	20,59	3.1/4"	3/4"	23,93	3.1/4"	2.5/8"	10,04	3.3/8"	2.1/8"	17,27
3.1/8"	1.1/4"	19,94	3.1/4"	7/8"	23,50	3.1/4"	2.3/4"	8,54	3.3/8"	2.1/4"	16,06
3.1/8"	1.3/8"	19,23	3.1/4"	1"	23,00	3.3/8"	1/2"	26,53	3.3/8"	2.3/8"	14,78
3.1/8"	1.1/2"	18,45	3.1/4"	1.1/8"	22,43	3.3/8"	5/8"	26,24	3.3/8"	2.1/2"	13,42
3.1/8"	1.5/8"	17,59	3.1/4"	1.1/4"	21,79	3.3/8"	3/4"	25,89	3.3/8"	2.5/8"	12,00
3.1/8"	1.3/4"	16,67	3.1/4"	1.3/8"	21,08	3.3/8"	7/8"	25,46	3.3/8"	2.3/4"	10,50
3.1/8"	1.7/8"	15,67	3.1/4"	1.1/2"	20,30	3.3/8"	1"	24,96	3.3/8"	2.7/8"	8,93
3.1/8"	2"	14,60	3.1/4"	1.5/8"	19,44	3.3/8"	1.1/8"	24,39	3.1/2"	1/2"	28,49
3.1/8"	2.1/8"	13,46	3.1/4"	1.3/4"	18,52	3.3/8"	1.1/4"	23,75	3.1/2"	5/8"	28,21

BUJES - PESO POR PIEZA CON 500 MM

Diámetro externo	Diámetro interno	Peso	Diámetro externo	Diámetro interno	Peso	Diámetro externo	Diámetro interno	Peso	Diámetro externo	Diámetro interno	Peso
3.1/2"	3/4"	27,85	3.1/2"	2.5/8"	13,96	3.5/8"	1.7/8"	23,51	3.3/4"	1"	31,13
3.1/2"	7/8"	27,43	3.1/2"	2.3/4"	12,46	3.5/8"	2"	22,44	3.3/4"	1.1/8"	30,56
3.1/2"	1"	26,93	3.1/2"	2.7/8"	10,90	3.5/8"	2.1/8"	21,30	3.3/4"	1.1/4"	29,92
3.1/2"	1.1/8"	26,36	3.1/2"	3"	9,25	3.5/8"	2.1/4"	20,09	3.3/4"	1.3/8"	29,21
3.1/2"	1.1/4"	25,71	3.5/8"	1/2"	30,56	3.5/8"	2.3/8"	18,81	3.3/4"	1.1/2"	28,42
3.1/2"	1.3/8"	25,00	3.5/8"	5/8"	30,28	3.5/8"	2.1/2"	17,45	3.3/4"	1.5/8"	27,57
3.1/2"	1.1/2"	24,22	3.5/8"	3/4"	29,92	3.5/8"	2.5/8"	16,03	3.3/4"	1.3/4"	26,64
3.1/2"	1.5/8"	23,36	3.5/8"	7/8"	29,50	3.5/8"	2.3/4"	14,53	3.3/4"	1.7/8"	25,64
3.1/2"	1.3/4"	22,44	3.5/8"	1.	29,00	3.5/8"	2.7/8"	12,96	3.3/4"	2"	24,57
3.1/2"	1. 7/8"	21,44	3.5/8"	1.1/8"	28,43	3.5/8"	3"	11,32	3.3/4"	2.1/8"	23,44
3.1/2"	2"	20,37	3.5/8"	1.1/4"	27,78	3.5/8"	3.1/8"	9,61	3.3/4"	2.1/4"	22,22
3.1/2"	2.1/8"	19,23	3.5/8"	1.3/8"	27,07	3.3/4"	1/2"	32,70	3.3/4"	2.3/8"	20,94
3.1/2"	2.1/4"	18,02	3.5/8"	1.1/2"	26,29	3.3/4"	5/8"	32,41	3.3/4"	2.1/2"	19,59
3.1/2"	2.3/8"	16,74	3.5/8"	1.5/8"	25,43	3.3/4"	3/4"	32,06	3.3/4"	2.5/8"	18,16
3.1/2"	2.1/2"	15,38	3.5/8"	1.3/4"	24,51	3.3/4"	7/8"	31,63	3.3/4"	2.3/4"	16,66

BUJES - PESO POR PIEZA CON 500 MM

Diámetro externo	Diámetro interno	Peso	Diámetro externo	Diámetro interno	Peso	Diámetro externo	Diámetro interno	Peso	Diámetro externo	Diámetro interno	Peso
4"	1.7/8"	30,13	4.1/8"	5/8"	39,24	4.1/8"	2.1/2"	26,42	4.3/8"	1"	42,89
4"	2"	29,06	4.1/8"	3/4"	38,89	4.1/8"	2.5/8"	24,99	4.3/8"	1.1 /8"	42,32
4"	2.1/8"	27,92	4.1/8"	7/8"	38,46	4.1/8"	2.3/4"	23,50	4.3/8"	1.1/4"	41,68
4"	2.1/4"	26,71	4.1/8"	1"	37,96	4.1/8"	2.7/8"	21,93	4.3/8"	1.3/8"	40,97
4"	2.3/8"	25,43	4.1/8"	1.1/8"	37,39	4.1/4"	3"	22,72	4.3/8"	1.1/2"	40,18
4"	2.1/2"	24,07	4.1/8"	1.1 /4"	36,75	4.1/4"	3.1/8"	21,01	4.3/8"	1.5/8"	39,33
4"	2.5/8"	22,65	4.1/8"	1.3/8"	36,04	4.1/4"	3.1/4"	19,23	4.3/8"	1.3/4"	38,40
4"	2.3/4"	21,15	4.1/8"	1.1 /2"	35,25	4.1/4"	3.3/8"	17,34	4.3/8"	1.7/8"	37,40
4"	2.7/8"	19,58	4.1/8"	1.5/8"	34,40	4.1/4"	3.1/2"	15,45	4.3/8"	2"	36,33
4"	3"	17,94	4.1/8"	1.3/4"	33,47	4.1/4"	3.5/8"	13,45	4.3/8"	2.1/8"	35,19
4"	3.1/8"	16,23	4.1/8"	1.7/8"	32,47	4.1/4"	3.3/4"	11,39	4.3/8"	2.1/4"	33,98
4"	3.1/4"	14,45	4.1/8"	2"	31,40	4.3/8"	1/2"	44,46	4.3/8"	2.3/8"	32,70
4"	3.3/8"	12,57	4.1/8"	2.1/8"	30,27	4.3/8"	5/8"	44,17	4.3/8"	2.1/2"	31,34
4"	3.1/2"	10,68	4.1/8"	2.1/4"	29,05	4.3/8"	3/4"	43,82	4.3/8"	2.5/8"	29,92
4.1/8"	1/2"	39,53	4.1/8"	2.3/8"	27,77	4.3/8"	7/8"	43,39	4.3/8"	2.3/4"	28,42

BUJES - PESO POR PIEZA CON 500 MM

Diámetro externo	Diámetro interno	Peso	Diámetro externo	Diámetro interno	Peso	Diámetro externo	Diámetro interno	Peso	Diámetro externo	Diámetro interno	Peso
4.3/8"	2.7/8"	26,86	4.1/2"	1.3/4"	40,96	4.1/2"	3.5/8"	18,51	4.5/8"	2.3/8"	37,89
4.3/8"	3"	25,22	4.1/2"	1.7/8"	39,96	4.1/2"	3.3/4"	16,45	4.5/8"	2.1/2"	36,54
4.3/8"	3.1/8"	23,50	4.1/2"	2"	38,89	4.1/2"	3.7/8"	14,31	4.5/8"	2.5/8"	35,11
4.3/8"	3.1/4"	21,72	4.1/2"	2.1/8"	37,76	4.1/2"	4"	12,10	4.5/8"	2.3/4"	33,62
4.3/8"	3.3/8"	19,84	4.1/2"	2.1/4"	36,54	4.5/8"	1"	48,08	4.5/8"	2.7/8"	32,05
4.3/8"	3.1/2"	17,95	4.1/2"	2.3/8"	35,26	4.5/8"	1.1/8"	47,51	4.5/8"	3"	30,41
4.3/8"	3.5/8"	15,95	4.1/2"	2.1/2"	33,91	4.5/8"	1.1/4"	46,87	4.5/8"	3.1/8"	28,70
4.3/8"	3.3/4"	13,89	4.1/2"	2.5/8"	32,48	4.5/8"	1.3/8"	46,16	4.5/8"	3.1/4"	26,92
4.3/8"	3.7/8"	11,75	4.1/2"	2.3/4"	30,98	4.5/8"	1.1/2"	45,37	4.5/8"	3.3/8"	25,03
4.1/2"	1"	45,45	4.1/2"	2.7/8"	29,42	4.5/8"	1.5/8"	44,52	4.5/8"	3.1/2"	23,14
4.1/2"	1.1/8"	44,88	4.1/2"	3"	27,78	4.5/8"	1.3/4"	43,59	4.5/8"	3.5/8"	21,14
4.1/2"	1.1/4"	44,24	4.1/2"	3.1/8"	26,06	4.5/8"	1.7/8"	42,60	4.5/8"	3.3/4"	19,08
4.1/2"	1.3/8"	43,53	4.1/2"	3.1/4"	24,29	4.5/8"	2"	41,53	4.5/8"	3.7/8"	16,94
4.1/2"	1.1/2"	42,74	4.1/2"	3.3/8"	22,40	4.5/8"	2.1/8"	40,39	4.5/8"	4"	14,73
4.1/2"	1.5/8"	41,89	4.1/2"	3.1/2"	20,51	4.5/8"	2.1/4"	39,17	4.5/8"	4.1/8"	12,46

BUJES - PESO POR PIEZA CON 500 MM

Diámetro externo	Diámetro interno	Peso	Diámetro externo	Diámetro interno	Peso	Diámetro externo	Diámetro interno	Peso	Diámetro externo	Diámetro interno	Peso
4.3/4"	1"	50,79	4.3/4"	2.7/8"	34,76	4.7/8"	1.3/8"	51,64	4.7/8"	3.1/4"	32,40
4.3/4"	1.1/8"	50,22	4.3/4"	3"	33,12	4.7/8"	1.1/2"	50,85	4.7/8"	3.3/8"	30,51
4.3/4"	1.1/4"	49,58	4.3/4"	3.1/8"	31,41	4.7/8"	1.5/8"	50,00	4.7/8"	3.1/2"	28,62
4.3/4"	1.3/8"	48,87	4.3/4"	3.1/4"	29,63	4.7/8"	1.3/4"	49,07	4.7/8"	3.5/8"	26,62
4.3/4"	1.1/2"	48,09	4.3/4"	3.3/8"	27,74	4.7/8"	1.7/8"	48,07	4.7/8"	3.3/4"	24,56
4.3/4"	1.5/8"	47,23	4.3/4"	3.1/2"	25,85	4.7/8"	2"	47,00	4.7/8"	3.7/8"	22,42
4.3/4"	1.3/4"	46,30	4.3/4"	3.5/8"	23,85	4.7/8"	2.1/8"	45,87	4.7/8"	4"	20,22
4.3/4"	1.7/8"	45,31	4.3/4"	3.3/4"	21,79	4.7/8"	2.1/4"	44,65	4.7/8"	4.1/8"	17,94
4.3/4"	2"	44,24	4.3/4"	3.7/8"	19,65	4.7/8"	2.3/8"	43,37	4.7/8"	4.1/4"	15,58
4.3/4"	2.1/8"	43,10	4.3/4"	4"	17,44	4.7/8"	2.1/2"	42,02	4.7/8"	4.3/8"	13,16
4.3/4"	2.1/4"	41,89	4.3/4"	4.1/8"	15,17	4.7/8"	2.5/8"	40,59	5"	1"	56,41
4.3/4"	2.3/8"	40,60	4.3/4"	4.1/4"	12,81	4.7/8"	2.3/4"	39,09	5"	1.1/8"	55,84
4.3/4"	2.1/2"	39,25	4.7/8"	1"	53,56	4.7/8"	2.7/8"	37,53	5"	1.1/4"	55,20
4.3/4"	2.5/8"	37,83	4.7/8"	1.1/8"	52,99	4.7/8"	3"	35,89	5"	1.3/8"	54,49
4.3/4"	2.3/4"	36,33	4.7/8"	1.1/4"	52,35	4.7/8"	3.1/8"	34,18	5"	1.1/2"	53,70

BUJES - PESO POR PIEZA CON 500 MM

Diámetro externo	Diámetro interno	Peso	Diámetro externo	Diámetro interno	Peso	Diámetro externo	Diámetro interno	Peso	Diámetro externo	Diámetro interno	Peso
5"	1.5/8"	52,85	5"	3.1/2"	31,48	5.1/8"	1.3/4"	54,85	5.1/8"	3.5/8"	32,40
5"	1.3/4"	51,92	5"	3.5/8"	29,48	5.1/8"	1.7/8"	53,85	5.1/8"	3.3/4"	30,34
5"	1.7/8"	50,93	5"	3.3/4"	27,41	5.1/8"	2"	52,78	5.1/8"	3.7/8"	28,19
5"	2"	49,86	5"	3.7/8"	25,27	5.1/8"	2.1/8"	51,64	5.1/8"	4"	25,99
5"	2.1/8"	48,72	5"	4"	23,07	5.1/8"	2.1/4"	50,43	5.1/8"	4.1/8"	23,71
5"	2.1/4"	47,51	5"	4.1/8"	20,79	5.1/8"	2.3/8"	49,15	5.1/8"	4.1/4"	21,36
5"	2.3/8"	46,23	5"	4.1/4"	18,44	5.1/8"	2.1/2"	47,79	5.1/8"	4.3/8"	18,93
5"	2.1/2"	44,87	5"	4.3/8"	16,01	5.1/8"	2.5/8"	46,37	5.1/8"	4.1/2"	16,44
5"	2.5/8"	43,45	5"	4.1/2"	13,52	5.1/8"	2.3/4"	44,87	5.1/8"	4.5/8"	13,88
5"	2.3/4"	41,95	5.1/8"	1"	59,34	5.1/8"	2.7/8"	43,31	5.1/4"	1"	62,34
5"	2.7/8"	40,38	5.1/8"	1.1/8"	58,77	5.1/8"	3"	41,67	5.1/4"	1.1/8"	61,77
5"	3"	38,74	5.1/8"	1.1/4"	58,13	5.1/8"	3.1/8"	39,95	5.1/4"	1.1/4"	61,12
5"	3.1/8"	37,03	5.1/8"	1.3/8"	57,42	5.1/8"	3.1/4"	38,17	5.1/4"	1.3/8"	60,41
5"	3.1/4"	35,25	5.1/8"	1.1/2"	56,63	5.1/8"	3.3/8"	36,29	5.1/4"	1.1/2"	59,63
5"	3.3/8"	33,37	5.1/8"	1.5/8"	55,78	5.1/8"	3.1/2"	34,40	5.1/4"	1.5/8"	58,77

BUJES - PESO POR PIEZA CON 500 MM

Diámetro externo	Diámetro interno	Peso	Diámetro externo	Diámetro interno	Peso	Diámetro externo	Diámetro interno	Peso	Diámetro externo	Diámetro interno	Peso
5.1/4"	1.3/4"	57,85	5.1/4"	3.5/8"	35,40	5.3/8"	1.5/8"	61,84	5.3/8"	3.1/2"	40,46
5.1/4"	1.7/8"	56,85	5.1/4"	3.3/4"	33,33	5.3/8"	1.3/4"	60,91	5.3/8"	3.5/8"	38,46
5.1/4"	2"	55,78	5.1/4"	3.7/8"	31,19	5.3/8"	1.7/8"	59,92	5.3/8"	3.3/4"	36,40
5.1/4"	2.1/8"	54,64	5.1/4"	4"	28,99	5.3/8"	2"	58,85	5.3/8"	3.7/8"	34,26
5.1/4"	2.1/4"	53,43	5.1/4"	4.1/8"	26,71	5.3/8"	2.1/8"	57,71	5.3/8"	4"	32,05
5.1/4"	2.3/8"	52,15	5.1/4"	4.1/4"	24,35	5.3/8"	2.1/4"	56,50	5.3/8"	4.1/8"	29,78
5.1/4"	2.1/2"	50,79	5.1/4"	4.3/8"	21,93	5.3/8"	2.3/8"	55,22	5.3/8"	4.1/4"	27,42
5.1/4"	2.5/8"	49,37	5.1/4"	4.1/2"	19,44	5.3/8"	2.1/2"	53,86	5.3/8"	4.3/8"	25,00
5.1/4"	2.3/4"	47,87	5.1/4"	4.5/8"	16,88	5.3/8"	2.5/8"	52,44	5.3/8"	4.1/2"	22,51
5.1/4"	2.7/8"	46,30	5.1/4"	4.3/4"	14,24	5.3/8"	2.3/4"	50,94	5.3/8"	4.5/8"	19,95
5.1/4"	3"	44,66	5.3/8"	1.	65,40	5.3/8"	2.7/8"	49,37	5.3/8"	4.3/4"	17,30
5.1/4"	3.1/8"	42,95	5.3/8"	1.1/8"	64,83	5.3/8"	3"	47,73	5.3/8"	4.7/8"	14,60
5.1/4"	3.1/4"	41,17	5.3/8"	1.1/4"	64,19	5.3/8"	3.1/8"	46,02	5.1/2"	1"	68,53
5.1/4"	3.3/8"	39,29	5.3/8"	1.3/8"	63,48	5.3/8"	3.1/4"	44,24	5.1/2"	1.1/8"	67,96
5.1/4"	3.1/2"	37,39	5.3/8"	1.1/2"	62,70	5.3/8"	3.3/8"	42,35	5.1/2"	1.1/4"	67,32

BUJES - PESO POR PIEZA CON 500 MM

Diámetro externo	Diámetro interno	Peso	Diámetro externo	Diámetro interno	Peso	Diámetro externo	Diámetro interno	Peso	Diámetro externo	Diámetro interno	Peso
5.1/2"	1.3/8"	66,61	5.1/2"	3.5/8"	41,59	5.5/8"	1.5/8"	68,16	5.5/8"	3.3/4"	42,72
5.1/2"	1.1/2"	65,83	5.1/2"	3.3/4"	39,52	5.5/8"	1.3/4"	67,23	5.5/8"	3.7/8"	40,58
5.1/2"	1.5/8"	64,97	5.1/2"	3.7/8"	37,38	5.5/8"	1.7/8"	66,24	5.5/8"	4"	38,38
5.1/2"	1.3/4"	64,04	5.1/2"	4"	35,18	5.5/8"	2"	65,17	5.5/8"	4.1/8"	36,10
5.1/2"	1.7/8"	63,05	5.1/2"	4.1/8"	32,90	5.5/8"	2.1/8"	64,03	5.5/8"	4.1/4"	33,75
5.1/2"	2"	61,98	5.1/2"	4.1/4"	30,55	5.5/8"	2.1/4"	62,82	5.5/8"	4.3/8"	31,32
5.1/2"	2.1/8"	60,84	5.1/2"	4.3/8"	28,12	5.5/8"	2.3/8"	61,54	5.5/8"	4.1/2"	28,83
5.1/2"	2.1/4"	59,63	5.1/2"	4.1/2"	25,63	5.5/8"	2.1/2"	60,18	5.5/8"	4.5/8"	26,27
5.1/2"	2.3/8"	58,35	5.1/2"	4.5/8"	23,07	5.5/8"	2.5/8"	58,76	5.5/8"	4.3/4"	23,63
5.1/2"	2.1/2"	56,99	5.1/2"	4.3/4"	20,43	5.5/8"	2.3/4"	57,26	5.5/8"	4.7/8"	20,93
5.1/2"	2.5/8"	55,57	5.1/2"	4.7/8"	17,73	5.5/8"	2.7/8"	55,69	5.5/8"	5"	18,15
5.1/2"	2.3/4"	54,07	5.1/2"	5"	14,95	5.5/8"	3"	54,05	5.5/8"	5.1/8"	15,30
5.1/2"	3"	50,86	5.5/8"	1"	71,72	5.5/8"	3.1/8"	52,34	5.3/4"	1"	75,00
5.1/2"	3.1/8"	49,15	5.5/8"	1.1/8"	71,15	5.5/8"	3.1/4"	50,56	5.3/4"	1.1/8"	74,44
5.1/2"	3.1/4"	47,37	5.5/8"	1.1 /4"	70,51	5.5/8"	3.3/8"	48,68	5.3/4"	1.1 /4"	73,79
5.1/2"	3.3/8"	45,48	5.5/8"	1.3/8"	69,80	5.5/8"	3.1/2"	46,79			
5.1/2"	3.1/2"	43,59	5.5/8"	1.1 /2"	69,01	5.5/8"	3.5/8"	44,79			

BUJES - PESO POR PIEZA CON 500 MM

Diámetro externo	Diámetro interno	Peso	Diámetro externo	Diámetro interno	Peso	Diámetro externo	Diámetro interno	Peso	Diámetro externo	Diámetro interno	Peso
5.3/4"	1.3/8"	73,08	5.3/4"	3.1/2"	50,08	5.7/8"	2.1/4"	69,45	5.7/8"	4.3/8"	37,95
5.3/4"	1.1/2"	72,30	5.3/4"	3.5/8"	48,08	5.7/8"	2.3/8"	68,17	5.7/8"	4.1/2"	35,46
5.3/4"	1.5/8"	71,44	5.3/4"	3.3/4"	46,01	5.7/8"	2.1/2"	66,82	5.7/8"	4.5/8"	32,90
5.3/4"	1.3/4"	70,52	5.3/4"	3.7/8"	43,87	5.7/8"	2.5/8"	65,39	5.7/8"	4.3/4"	30,26
5.3/4"	1.7/8"	69,52	5.3/4"	4"	41,67	5.7/8"	2.3/4"	63,89	5.7/8"	4.7/8"	27,56
5.3/4"	2"	68,45	5.3/4"	4.1/8"	39,39	5.7/8"	2.7/8"	62,33	5.7/8"	5"	24,77
5.3/4"	2.1/8"	67,32	5.3/4"	4.1/4"	37,04	5.7/8"	3"	60,69	5.7/8"	5.1/8"	21,93
5.3/4"	2.1/4"	66,11	5.3/4"	4.3/8"	34,61	5.7/8"	3.1/8"	58,97	5.7/8"	5.1/4"	19,00
5.3/4"	2.3/8"	64,83	5.3/4"	4.1/2"	32,12	5.7/8"	3.1/4"	57,20	5.7/8"	5.3/8"	16,01
5.3/4"	2.1/2"	63,47	5.3/4"	4.5/8"	29,56	5.7/8"	3.3/8"	55,31	6"	2"	75,23
5.3/4"	2.5/8"	62,05	5.3/4"	4.3/4"	26,92	5.7/8"	3.1/2"	53,42	6"	2.1/8"	74,09
5.3/4"	2.3/4"	60,55	5.3/4"	4.7/8"	24,21	5.7/8"	3.5/8"	51,42	6"	2.1/4"	72,88
5.3/4"	2.7/8"	58,99	5.3/4"	5"	21,43	5.7/8"	3.3/4"	49,36	6"	2.3/8"	71,60
5.3/4"	3"	57,34	5.3/4"	5.1/8"	18,59	5.7/8"	3.7/8"	47,22	6"	2.1/2"	70,24
5.3/4"	3.1/8"	55,63	5.3/4"	5.1/4"	15,66	5.7/8"	4"	45,01	6"	2.5/8"	68,82
5.3/4"	3.1/4"	53,85	5.7/8"	2"	71,80	5.7/8"	4.1/8"	42,73			
5.3/4"	3.3/8"	51,97	5.7/8"	2.1/8"	70,67	5.7/8"	4.1/4"	40,38			

BUJES - PESO POR PIEZA CON 500 MM

Diámetro externo	Diámetro interno	Peso	Diámetro externo	Diámetro interno	Peso	Diámetro externo	Diámetro interno	Peso	Diámetro externo	Diámetro interno	Peso
6"	2.3/4"	67,32	6"	4.7/8"	30,98	6.1/4"	4.3/4"	40,74	6.1/2"	5.1/2"	30,76
6"	2.7/8"	65,75	6"	5"	28,20	6.1/4"	5"	35,25	6.3/4"	2"	97,23
6"	3"	64,11	6"	5.1/8"	25,35	6.1/4"	5.1/4"	29,48	6.3/4"	2.1/4"	94,88
6"	3.1/8"	62,40	6"	5.1/4"	22,43	6.1/2"	2"	89,62	6.3/4"	2.1/2"	92,24
6"	3.1/4"	60,62	6"	5.3/8"	19,43	6.1/2"	2.1/4"	87,27	6.3/4"	2.3/4"	89,32
6"	3.3/8"	58,74	6"	5.1/2"	16,37	6.1/2"	2.1/2"	84,63	6.3/4"	3"	86,11
6"	3.1/2"	56,84	6.1/4"	2"	82,28	6.1/2"	2.3/4"	81,71	6.3/4"	3.1/4"	82,62
6"	3.5/8"	54,85	6.1/4"	2.1/4"	79,93	6.1/2"	3"	78,50	6.3/4"	3.1/2"	78,85
6"	3.3/4"	52,78	6.1/4"	2.1/2"	77,29	6.1/2"	3.1/4"	75,01	6.3/4"	3.3/4"	74,79
6"	3.7/8"	50,64	6.1/4"	2.3/4"	74,37	6.1/2"	3.1/2"	71,24	6.3/4"	4"	70,44
6"	4"	48,44	6.1/4"	3"	71,17	6.1/2"	3.3/4"	67,17	6.3/4"	4.1/4"	65,81
6"	4.1/8"	46,16	6.1/4"	3.1/4"	67,67	6.1/2"	4"	62,83	6.3/4"	4.1/2"	60,89
6"	4.1/4"	43,80	6.1/4"	3.1/2"	63,90	6.1/2"	4.1/4"	58,20	6.3/4"	4.3/4"	55,69
6"	4.3/8"	41,38	6.1/4"	3.3/4"	59,84	6.1/2"	4.1/2"	53,28	6.3/4"	5"	50,21
6"	4.1/2"	38,89	6.1/4"	4"	55,49	6.1/2"	4.3/4"	48,07	6.3/4"	5.1/4"	44,44
6"	4.5/8"	36,33	6.1/4"	4.1/4"	50,86	6.1/2"	5"	42,58			
6"	4.3/4"	33,69	6.1/4"	4.1/2"	45,94	6.1/2"	5.1/4"	36,81			

BUJES - PESO POR PIEZA CON 500 MM

Diámetro externo	Diámetro interno	Peso	Diámetro externo	Diámetro interno	Peso	Diámetro externo	Diámetro interno	Peso	Diámetro externo	Diámetro interno	Peso
6.3/4"	5.1/2"	38,38	7.1/2"	3"	110,69	8.1/2"	3.1/2"	140,20	9.1/2"	6.1/2"	113,98
6.3/4"	5.3/4"	32,04	7.1/2"	3.1/2"	103,42	8.1/2"	4"	131,80	9.1/2"	7"	98,73
7"	2"	105,13	7.1/2"	4"	95,02	8.1/2"	4.1/2"	122,25	9.1/2"	7.1/2"	82,34
7"	2.1/4"	102,78	7.1/2"	4.1/2"	85,47	8.1/2"	5"	111,56	9.1/2"	8"	64,81
7"	2.1/2"	100,15	7.1/2"	5"	74,78	8.1/2"	5.1/2"	99,73	9.1/2"	8.1/2"	46,15
7"	2.3/4"	97,23	7.1/2"	5.1/2"	62,96	8.1/2"	6"	86,76	10"	4"	195,49
7"	3"	94,02	7.1/2"	6"	49,99	8.1/2"	6.1/2"	72,65	10"	4.1/2"	185,94
7"	3.1/4"	90,53	7.1/2"	6.1/2"	35,88	9"	4"	151,89	10"	5"	175,25
7"	3.1/2"	86,75	8"	3"	128,50	9"	4.1/2"	142,34	10"	5.1/2"	163,43
7"	3.3/4"	82,69	8"	3.1/2"	121,23	9"	5"	131,65	10"	6"	150,46
7"	4"	78,35	8"	4"	112,82	9"	5.1/2"	119,82	10"	6.1/2"	136,35
7"	4.1/4"	73,72	8"	4.1/2"	103,28	9"	6"	106,85	10"	7"	121,10
7"	4.1/2"	68,80	8"	5"	92,59	9.1/2"	4"	173,12	10"	7.1/2"	104,71
7"	4.3/4"	63,60	8"	5.1/2"	80,77	9.1/2"	4.1/2"	163,57	10"	8"	87,19
7"	5"	58,11	8"	6"	67,80	9.1/2"	5"	152,88	10.1/2"	4"	219,00
7"	5.1/4"	52,34	8"	6.1/2"	53,69	9.1/2"	5.1/2"	141,05			
7"	5.1/2"	46,29	8.1/2"	3"	147,45	9.1/2"	6"	128,09			

BUJES - PESO POR PIEZA CON 500 MM

Diámetro externo	Diámetro interno	Peso	Diámetro externo	Diámetro interno	Peso	Diámetro externo	Diámetro interno	Peso
10.1/2"	4.1/2"	209,45	11"	8"	135,35	12"	6"	251,35
10.1/2"	5"	198,77	11"	8.1/2"	116,68	12"	6.1/2"	237,24
10.1/2"	5.1/2"	186,94	11"	9"	96,87	12"	7"	221,99
10.1/2"	6"	173,97	11.1/2"	4"	270,69	12"	7.1/2"	205,60
10.1/2"	6.1/2"	159,86	11.1/2"	4.1/2"	261,14	12"	8"	188,07
10.1/2"	7"	144,61	11.1/2"	5"	250,46	12"	8.1/2"	169,40
10.1/2"	7.1/2"	128,23	11.1/2"	5.1/2"	238,63	12"	9"	149,60
10.1/2"	8"	110,70	11.1/2"	6"	225,66	12"	9.1/2"	128,65
10.1/2"	9"	72,22	11.1/2"	6.1/2"	211,55	12"	10"	106,56
11"	4"	243,65	11.1/2"	7"	196,30	12"	10.1/2"	83,33
11"	4.1/2"	234,11	11.1/2"	7.1/2"	179,92	12"	11"	58,96
11"	5"	223,42	11.1/2"	8"	162,39	13"	5"	333,43
11"	5.1/2"	211,59	11.1/2"	8.1/2"	143,72	13"	6"	308,63
11"	6"	198,62	12"	4"	296,38	13"	7"	279,27
11"	6.1/2"	184,51	12"	4.1/2"	286,83	13"	8"	245,36
11"	7"	169,27	12"	5"	276,14	13"	9"	206,88
11"	7.1/2"	152,88	12"	5.1/2"	264,31	13"	10"	163,84

bronce

BUJES - PESO POR PIEZA CON 500 MM

Diámetro externo	Diámetro interno	Peso
13"	11"	116,25
13"	12"	64,09
14"	5"	395,27
14"	6"	370,47
14"	7"	341,12
14"	8"	307,20
14"	9"	268,72
14"	10"	225,69
14"	11"	178,09
14"	12"	125,93
14"	13"	69,22

Diámetro externo	Diámetro interno	Peso
15	5"	461,67
15	6"	436,88
15	7"	407,52
15	8"	373,60
15	9"	335,13
15	10"	292,09
15	11"	244,49
15	12"	192,34
15	13"	135,62
15	14"	74,35

Position

Latón

El latón es una aleación metálica compuesta por la unión de átomos de cobre (Cu) y zinc (Zn). Ampliamente utilizado por la humanidad hace más de 4 mil años, esa aleación presenta un brillo parecido al de oro y es muy maleable. Algunas de sus características son:

- ▶ Alta ductilidad;
- ▶ Alta conductibilidad térmica y eléctrica;
- ▶ Alto coste beneficio;
- ▶ Alta versatilidad de producción;
- ▶ Alta resistencia a la corrosión;
- ▶ Alta resistencia mecánica.

La alta resistencia a la corrosión y choques mecánicos del latón lo vuelve en un material de manejo práctico, pudiendo forjarse, laminarse, fundirse y estirarse frío con más facilidad que el cobre y el zinc separadamente.



PRINCIPALES ALEACIONES, FORMATOS, CARACTERÍSTICAS Y APLICACIONES parte 1/3

Denominación	Aleaciones ASTM/UNS	Formato	Características	Aplicaciones
Latón Tomback 90/10	C22000	Bobinas, Placa/Plancha, Tiras	Excelente confortabilidad a frio y buena confortabilidad a caliente. Excelente soldadura y brazaje.	Bisuterías en general, ornamental, artículos esmaltados, tinturaría para munición.
Latón Tomback 85/15	C23000	Bobinas, Placa/Plancha, Tiras	Excelente confortabilidad a frio y mediana confortabilidad a caliente. Excelente soldadura y brazaje.	Extintores de incendio, ojales, zippers, botones de presión, bisuterías, tinturarías para munición.
Latón 70/30	C26000	Bobinas, Placa/Plancha, Tiras, Tubos	Excelente confortabilidad a frio y mediana confortabilidad a caliente. Excelente soldadura y brazaje.	Tubos para radiadores, instrumentos musicales, rebites, tornillos, reflectores, enchufes, botones de presión, zippers, bisagras, tinturaría para munición, metales sanitarios.
Latón 67/33	C26800	Bobinas, Placa/Plancha, Tiras, Barras Rectangulares	Excelente confortabilidad a frio y mediana confortabilidad a caliente. Excelente soldadura y brazaje.	Reflectores, soquetes para lámparas, ojales, bisagras, cerraduras, componentes obtenidos por llenado profundo y surtidor, aletas, rebites, pinos, tornillos, muelles.
Latón 65/35	C27000	Alambres, Barras Rectangulares	Excelente confortabilidad a frio y mala confortabilidad a caliente. Excelente soldadura y brazaje.	Pinos, rebites, tornillos, muelles, bisagras, ojales, Pinos, rebites, tornillos, muelles, bisagras, ojales, objetos de adorno.
Latón 63/37	C27200	Tubos	Buena confortabilidad a frio y a caliente. Excelente soldadura y brazaje.	Tubos para radiadores, antenas para radio, televisión y vehículos, metales sanitarios.

PRINCIPALES ALEACIONES, FORMATOS, CARACTERÍSTICAS Y APLICACIONES parte 2/3

Denominación	Aleaciones ASTM/UNS	Formato	Características	Aplicaciones
Latón Herrería flex	C35300	Tiras	Mediana confortabilidad a frío y a caliente. Excelente soldadura y brazaje.	Llaves, componentes de cerraduras, engranajes en general, placas grabadas..
Latón Corte Libre Americano CLA	C36000	Barras Rectangulares	Limitada confortabilidad a frío y mediana a caliente. Excelente soldadura y buena brazaje.	Piezas a producirse en torno automáticos de alta, velocidad de corte así como: tornillos, pinos, tuercas, arandelas, bujes, cojinetes, piezas tubulares, piezas de industria en general.
Latón Herrería	C37700	Barras	Limitada confortabilidad a frío y excelente confortabilidad a caliente. Excelente soldadura y buena brazaje.	Piezas a forjarse o prensarse a caliente, como: metales sanitarios, herramientas para puertas y ventanas, válvulas y registros, piezas de autos, engranajes, tuercas, uniones, etc. Engranajes y similares solicitando alta precisión de usina.
Latón Corte Libre Europeu CLE	C38500	Barras	Limitada confortabilidad a frío y buena confortabilidad a caliente. Excelente soldadura y buena brazaje.	Piezas a industrializarse en tornos automáticos de alta
Latón Almirantado (Arsenical)	C44300	Tubos	Buena confortabilidad a frío y mediana confortabilidad a caliente. Excelente soldadura y buena brazaje.	Condensadores, evaporadores, trocadores de calor, tubos para agua salgada.

PRINCIPALES ALEACIONES, FORMATOS, CARACTERÍSTICAS Y APLICACIONES **parte 3/3**

Denominación	Aleaciones ASTM/UNS	Formato	Características	Aplicaciones
Latón Almirantado (Fosforoso)	C44500	Tubos	Buena confortabilidad a frio y mediana confortabilidad a caliente. Excelente soldadura y buena brazaje.	Acondicionadores, evaporadores, intercambiadores de calor, tubos de agua salada.
Latón Naval	C46500	Laminados	Mala confortabilidad a frio y excelente confortabilidad a caliente. Excelente soldadura y buena brazaje.	Componentes para equipos marítimos, hélices, espejos para condensadores e intercambiadores de calor.
Latón Solda	C47100	Varilla	Mediana confortabilidad a frio y excelente confortabilidad a caliente. Excelente soldadura y buena brazaje.	Soldadura
Latón Aluminado	C68700	Tubos	Buena confortabilidad a frio y mediana confortabilidad a caliente. Excelente soldadura y buena brazaje.	Condensadores, evaporadores, intercambiadores de calor, tubos para agua salada

COMPOSICIÓN QUÍMICA DEL LATÓN

parte 1/2

Denominación	Aleaciones ASTM/UNS	Cu (%)	Zn (%)	Pb (%)	P (%)	Sn (%)	Fe (%)	Al (%)	Ni (%)	Mn (%)	As (%)	Outros (%)
Latón Tomback 90/10	C22000	89.00	restante	0.05			0.05					0.10
		91.00										
Latón Tomback 85/15	C23000	84.00	restante	0.05			0.05					0.15
		86.00										
Latón 70/30	C26000	68.50	restante	0.07			0.05					0.15
		71.50										
Latón 67/33	C26800	64.00	restante	0.15			0.05					0.15
		68.50										
Latón 65/35	C27000	63.00	restante	0.10			0.05					0.15
		68.50										
Latón 63/37	C27200	62.00	restante	0.07			0.05					0.15
		65.00										
Latón Herreríaaflex	C35300	59.00	restante	1.30			0.1					0.50
		64.50		2.30								

COMPOSICIÓN QUÍMICA DEL LATÓN

parte 2/2

Denominación	Aleaciones ASTM/UNS	Cu (%)	Zn (%)	Pb (%)	P (%)	Sn (%)	Fe (%)	Al (%)	Ni (%)	Mn (%)	As (%)	Outros (%)
Latón Corte Libre	C36000	60.00	restante	2.50			0.35					0.50
Americano CLA		63.00		3.70								
Latón Herrería	C37700	58.00	restante	1.50			0.3					0.50
		62.00		2.50								
Latón Corte Libre	C38500	55.00	restante	2.50			0.35					0.50
Europeu CLE		59.00		3.50								
Latón Almirantado	C44300	70.00	restante	0.07		0,9 1,20	0.06				0.02	0.15
(Arsenical)		73.00				0.06						
Latón Almirantado (Fosforoso)	C44500	70 73	restante	0.07	0,02 0,10	0,9 1,20	0.06					0.15
Latón Naval	C46500	59.00	restante	0.20		0.5	0.10				0.02	0.06
		62.00				1.00						
Latón Solda	C47100	62.00 (mín.)	restante			0.50						Si=0,35
Latão Aluminado	C68700	76.00 79.00	restante	0.07			0.06	1.80 2.50			0.02 0.10	0.15

Notas:

1. Los valores mencionados representan límites máximos por elemento químico, salvo si se indican intervalos entre mínimo y máximo.
2. Los valores indicados no darán lugar a garantía formal.

PROPIEDADES MECÁNICAS DEL LATÓN

parte 1/3

Denominación	Aleaciones ASTM/UNS	Formato	Temple	Límite de Resistencia a la Tracción (kgf/mm ²)	Límite de Fluencia	Alargamiento Mínimo	Dureza Brinell (HB)
					(kgf/mm ²)	"50,80 mm" (%)	
Latón Tomback 90/10	C22000	Bobinas, placa/ plancha, tiras	Recocido	28	10	48	60
			1/2 Duro	43	35	10	120
Latón Tomback 85/15	C23000	Bobinas, placa/ plancha, tiras	Recocido	31	13	40	80
			1/2 Duro	38	30	22	105
Latón 70/30	C26000	Bobinas, tiras	Recocido	35	14	57	80
			1/2 Duro	42	32	32	120
Latón 70/30	C26000	Tubos	1/2 Duro	48	42	15	135
Latón 67/33	C26800	Bobinas, chapas, tiras, barras rectangulares	Recocido	34	13	58	65
			1/2 Duro	43	33	30	120
Latón 65/35	C27000	Alambres	Recocido	35	-	60	-
			1/2 Duro	62		15	
Latón 65/35	C27000	Barras rectangulares	1/2 Duro	43	35	23	112

PROPIEDADES MECÁNICAS DEL LATÓN

parte 2/3

Denominación	Aleaciones ASTM/UNS	Formato	Temple	Límite de Resistencia a la Tracción (kgf/mm ²)	Límite de Fluencia	Alargamiento Mínimo	Dureza Brinell (HB)
					(kgf/mm ²)	"50,80 mm" (%)	
Latón 65/35	C27200	Tubos	1/2 Duro	42	33	28	110
Latón Herrería flex	C35300	Tiras	Duro	51	-	-	74
Latón Corte Libre	C36000	Barras, barras rectangulares	1/2 Duro	44	30	25	115
Americano CLA							
Latón Herrería	C37700	Barras	1/2 Duro	45	30	20	120
Latón Corte Libre	C38500	Barras	3/4 Duro	55	50	8	145
Europeu CLE							
Latón Almirantado (Arsenical)	C44300	Tubos	Recocido	37	15	65	70
Latón Almirantado (Fosforoso)	C44500	Tubos	Recocido	31	10	-	-
Latón Naval	C46500	Laminados	Laminado en Caliente	35	14	35	87

PROPIEDADES MECÁNICAS DEL LATÓN

parte 3/3

Denominación	Aleaciones ASTM/UNS	Formato	Temple	Límite de Resistencia a la Tracción (kgf/mm ²)	Límite de Fluencia	Alargamiento Mínimo "50,80 mm" (%)	Dureza Brinell (HB)
					(kgf/mm ²)		
Latón Solda	C47100	Varilla	Recocido	38	18	50	100
Latón Aluminado	C68700	Tubos	Recocido	38	14	60	76

Notas: Los valores indicados no darán lugar a garantía formal.

PROPIEDADES FÍSICAS DEL LATÓN

parte 1/3

Denominación	Aleaciones ASTM/UNS	Densidad a 20 °C p=peso específico (g/cm ³)	Punto de Fusión (°C)	Conductividad Térmica a 20 °C (cal/cm/cm ² /seg °C)	Calor Específico 20°C (cal/g°C)	Resistividad Eléctrica a 20 °C (material recocido) (μ/cm)	Conductividad Eléctrica a 20 °C (material recocido) (%IACS)	Coefficiente de Expansión Térmica 20 a 300 °C (10-6 °C)	Módulo de Elasticidad a 20°C (kg/mm ²)	Módulo de Rigidez a 20°C (kg/mm ²)
Latón Tombac 90/10	C22000	8.80	1,045	0.45	0.090	3.920	44	18.4	12,000	4,500
Latón Tombac 85/15	C23000	8.75	1,025	0.38	0.090	4.660	37	18.7	12,000	4,500
Latón 70/30	C26000	8.53	955	0.29	0.090	6.160	28	19.9	11,200	4,200
Latón 67/33	C26800	8.47	930	0.28	0.090	6.390	27	20.3	10,500	3,900
Latón 65/35	C27000	8.47	930	0.28	0.090	6.390	27	20.3	10,500	3,900
Latón 65/35	C27200	8.45	920	0.30	0.090	6.600	26	21.0	10,500	3,900

PROPIEDADES FÍSICAS DEL LATÓN

parte 2/3

Denominación	Aleaciones ASTM/UNS	Densidad a 20°C ρ =peso específico (g/cm ³)	Punto de Fusión (°C)	Conductividad Térmica a 20 °C (cal/cm/cm ² /seg °C)	Calor Específico 20°C (cal/g°C)	Resistividad Eléctrica a 20 °C (material recocido) (μ /cm)	Conductividad Eléctrica a 20 °C (material recocido) (%IACS)	Coefficiente de Expansión Térmica 20 a 300 °C (10-6 °C)	Módulo de Elasticidad a 20 °C (kg/mm ²)	Módulo de Rigidez a 20°C (kg/mm ²)
Latón Florjaflex	C35300	8.47	908	0.28	0.090	6.630	26	20.3	10,500	3,900
Latón Corte Libre Americano CLA	C36000	8.50	900	0.28	0.090	6.600	26	20.0	10,100	3,700
Latón Forja	C37700	8.40	895	0.28	0.090	6.400	27	21.0	9,800	3,600
Latón Corte Libre Europeu CLE	C38500	8.50	890	0.29	0.090	6.200	28	21.0	9,750	3,600
Latón Almirantado (Arsenical)	C44300	8.55	970	0.26	0.090	6.900	25	20.0	11,200	4,100

PROPIEDADES FÍSICAS DEL LATÓN



parte 3/3

Denominación	Aleaciones ASTM/UNS	Densidad a 20°C ρ =peso específico (g/cm ³)	Punto de Fusión (°C)	Conductividad Térmica a 20 °C (cal/cm/cm ² /seg °C)	Calor Específico 20°C (cal/g°C)	Resistividad Eléctrica a 20 °C (material recocido) (μ /cm)	Conductividad Eléctrica a 20 °C (material recocido) (%IACS)	Coefficiente de Expansión Térmica 20 a 300 °C (10 ⁻⁶ °C)	Módulo de Elasticidad a 20 °C (kg/mm ²)	Módulo de Rigidez a 20°C (kg/mm ²)
Latón Almirantado (Fosforoso)	C44500	8.55	970	0.26	0.090	6.900	25	20.0	11,200	4,100
Latón Naval	C46500	8.41	900	0.28	0.090	6.630	26	21.2	10,500	3,900
Latón Solda	C47100	8.45	900	0.24	-	-	22	20.9	-	-
Latón Aluminado	C68700	8.35	1,010	0.24	0.090	7.500	23	20.0	11,200	4,100

Notas: Los valores indicados no darán lugar a garantía formal.

VARILLAS - PESO POR METRO LINEAL



parte 1/2

Pulgada	Milímetro			
3/32"	2,38	0,038	0,042	0,048
1/8"	3,17	0,067	0,074	0,085
5/32"	3,97	0,105	0,116	0,134
3/16"	4,76	0,151	0,167	0,193
7/32"	5,55	0,206	0,227	0,262
1/4"	6,35	0,269	0,297	0,343
9/32"	7,14	0,340	0,375	0,433
5/16"	7,94	0,421	0,464	0,536
3/8"	9,53	0,606	0,669	0,772
7/16"	11,11	0,824	0,909	1,049
1/2"	12,70	1,077	1,187	1,371
9/16"	14,28	1,361	1,501	1,733
5/8"	15,87	1,681	1,854	2,141
11/16"	17,46	2,035	2,244	2,591
3/4"	19,05	2,423	2,671	3,085
13/16"	20,63	2,841	3,133	3,618
7/8"	22,22	3,296	3,634	4,197

Pulgada	Milímetro			
1 5/16"	23,81	3,785	4,173	4,819
1 "	25,40	4,307	4,749	5,484
1.1/16"	26,97	4,856	5,354	6,183
1.1/8"	28,57	5,449	6,008	6,938
1.3/16"	30,16	6,073	6,696	7,732
1.1/4"	31,75	6,730	7,420	8,569
1.5/16"	33,34	7,421	8,182	9,448
1.3/8"	34,92	8,141	8,976	10,365
1.7/16"	36,51	8,899	9,812	11,330
1.1/2"	38,10	9,691	10,685	12,339
1.9/16"	39,69	10,517	11,596	13,390
1.5/8"	41,27	11,370	12,537	14,477
5/8"	15,87	1,681	1,854	2,141
1.3/4"	44,45	13,190	14,544	16,794
1.7/8"	47,62	15,139	16,692	19,275
2"	50,80	17,228	18,996	21,935
2.1/16"	52,39	18,323	20,204	23,330

VARILLAS - PESO POR METRO LINEAL

parte 2/2

Pulgada	Milímetro			
2.1/8"	53,97	1 9,445	21,441	24,758
2.3/16"	55,56	20,608	22,723	26,239
2.1/4"	57,15	21 ,804	24,042	27,762
2.5/16"	58,73	23,027	25,390	29,318
2.3/8"	60,33	24,298	26,792	30,938
2.7/16"	61,91	25,588	28,21 4	32,579
2.1/2"	63,50	26,919	29,681	34,274
2.5/8"	66,68	29,683	32,729	37,793
2.3/4"	69,85	32,572	35,91 4	41,472
2.7/8"	73,03	35,605	39,259	45,334
3"	76,20	38,763	42,741	49,355
3.1/8"	79,39	42,077	46,395	53,574
3.1/4"	82,55	45,493	50,162	57,923
3.3/8"	85,73	49,065	54,101	62,472
3.1/2"	88,90	52,761	58,176	67,177
3.5/8"	92,08	56,603	62,412	72,069
3.3/4"	95,25	60,568	66,738	77,117

Pulgada	Milímetro			
3.7/8"	98,43	64,679	71,319	82,352
4"	101,60	68,912	75,984	87,742
4.1/2"	11 4,30	87,212	96,168	111,048
5"	127,00	107,676	1 18,726	1 37,097
6"	152,40	1 55,053	1 70,965	1 97,419
7"	1 77,80	211,044	232,702	268,709
8"	203,20	275,650	303,937	350,967
9"	228,60	348,869	384,671	444,193

BARRAS RECTANGULARES - PESO POR METRO LINEAL

parte 1/2

Ancho x Espesor		1/16" 1,58mm	3/32" 2,38mm	1/8" 3,17mm	3/16" 4,76mm	1/4" 6,35mm	5/16" 7,94mm	3/8" 9,53mm	1/2" 12,70mm	5/8" 15,87mm	3/4" 19,05mm
1,4"	6,35	0,085	0,128	0,171	0,257	--	--	--	--	--	--
5/16"	7,94	0,107	0,161	0,214	0,321	0,429	--	--	--	--	--
3/8"	9,53	0,128	0,193	0,257	0,386	0,514	0,643	--	--	--	--
7/16"	11,11	0,149	0,225	0,299	0,450	0,600	0,750	0,900	--	--	--
1/2 "	12,70	0,171	0,257	0,342	0,514	0,685	0,857	1,029	--	--	--
9/16"	14,28	0,192	0,289	0,385	0,578	0,771	0,964	1,157	1,542	--	--
5/8"	15,87	0,213	0,321	0,428	0,642	0,857	1,071	1,286	1,713	--	--
11/16"	17,46	0,234	0,353	0,470	0,706	0,942	1,178	1,414	1,885	2,355	--
3/4"	19,05	0,256	0,385	0,513	0,771	1,028	1,286	1,543	2,056	2,570	--
7/8"	22,22	0,298	0,450	0,599	0,899	1,199	1,500	1,800	2,399	2,997	3,598
1"	25,40	0,341	0,514	0,684	1,028	1,371	1,714	2,058	2,742	3,426	4,113
1.1/8"	28,57	0,384	0,578	0,770	1,156	1,542	1,928	2,314	3,084	3,854	4,626
1.1/4"	31,75	0,426	0,642	0,856	1,285	1,714	2,143	2,572	3,427	4,283	5,141
1.3/8"	34,92	0,469	0,706	0,941	1,413	1,885	2,357	2,829	3,770	4,711	5,654
1.1/2"	38,10	0,512	0,771	1,027	1,542	2,056	2,571	3,086	4,113	5,139	6,169
1.5/8"	41,27	0,554	0,835	1,112	1,670	2,228	2,785	3,343	4,455	5,567	6,683

BARRAS RECTANGULARES - PESO POR METRO LINEAL

parte 2/2

Ancho x Espesor		1/16" 1,58mm	3/32" 2,38mm	1/8" 3,17mm	3/16" 4,76mm	1/4" 6,35mm	5/16" 7,94mm	3/8" 9,53mm	1/2" 12,70mm	5/8" 15,87mm	3/4" 19,05mm
1.3/4"	44,45	0,597	0,899	1,198	1,798	2,399	3,000	3,601	4,798	5,996	7,198
1.7/8"	47,62	0,640	0,963	1,283	1,927	2,570	3,214	3,857	5,141	6,424	7,711
2"	50,80	0,682	1,028	1,369	2,055	2,742	3,428	4,115	5,484	6,853	8,226
2.1/4"	57,15	0,768	1,156	1,540	2,312	3,085	3,857	4,629	6,169	7,709	9,254
2.1/2"	63,50	0,853	1,285	1,711	2,569	3,427	4,286	5,144	6,855	8,566	10,282
2.3/4"	69,85	0,938	1,413	1,882	2,826	3,770	4,714	5,658	7,540	9,422	11,310
3"	76,20	1,023	1,542	2,053	3,083	4,113	5,143	6,173	8,226	10,279	12,339
3.1/4"	82,55	1,109	1,670	2,224	3,340	4,456	5,571	6,687	8,911	11,136	13,367
3.1/2"	88,90	1,194	1,798	2,395	3,597	4,798	6,000	7,201	9,597	11,992	14,395
3.3/4"	95,25	1,279	1,927	2,567	3,854	5,141	6,428	7,716	10,282	12,849	15,423
4"	101,60	1,364	2,055	2,738	4,111	5,484	6,857	8,230	10,968	13,705	16,452
4.1/2"	114,30	1,535	2,312	3,080	4,625	6,169	7,714	9,259	12,339	15,418	18,508
5"	127,00	1,706	2,569	3,422	5,138	6,855	8,571	10,288	13,710	17,132	20,564
5.1/2"	139,70	1,876	2,826	3,764	5,652	7,540	9,428	11,316	15,081	18,845	22,621
6"	152,40	2,047	3,083	4,106	6,166	8,226	10,285	12,345	16,452	20,558	24,677

TUBOS - PESO POR METRO LINEAL

parte 1/2

Diámetro externo		Espesor de la pared				
Pulgadas	Mm	1/32" 0,79mm	1,00mm	1/16" 1,58mm	3/32" 2,38mm	1/18" 3,17mm
1/8"	3,17	0,050	0,058	---	---	---
5/32"	3,97	0,067	0,079	0,101	---	---
3/16"	4,76	0,084	0,100	0,134	---	---
1/4"	6,35	0,117	0,143	0,201	0,252	---
5/16"	7,94	0,151	0,185	0,268	0,353	0,404
3/8"	9,53	0,184	0,228	0,335	0,454	0,538
7/16"	11,11	0,218	0,270	0,402	0,555	0,672
1/2"	12,70	0,251	0,312	0,469	0,656	0,807
9/16"	14,28	0,285	0,355	0,536	0,756	0,940
5/8"	15,87	0,318	0,397	0,603	0,857	1,075
3/4"	19,05	0,385	0,482	0,737	1,059	1,344
7/8"	22,22	0,452	0,567	0,871	1,261	1,613
1"	25,40	0,519	0,652	1,005	1,463	1,882
1.1/8"	28,57	0,586	0,736	1,139	1,664	2,150

Diámetro externo		Espesor de la pared				
Pulgadas	Mm	1/32" 0,79mm	1,00mm	1/16" 1,58mm	3/32" 2,38mm	1/18" 3,17mm
1.1/4"	31,75	0,653	0,821	1,273	1,867	2,419
1.3/8"	34,92	0,720	0,906	1,407	2,068	2,688
1.1/2"	38,10	0,787	0,991	1,541	2,270	2,957
1.5/8"	41,27	0,854	1,075	1,675	2,472	3,225
1.3/4"	44,45	0,921	1,160	1,809	2,674	3,494
1.7/8"	47,62	0,988	1,245	1,943	2,875	3,763
2"	50,80	1,055	1,330	2,077	3,077	4,032
2.1/8"	53,97	1,122	1,414	2,210	3,279	4,300
2.1/4"	57,15	1,189	1,499	2,345	3,481	4,569
2.3/8"	60,33	1,256	1,584	2,479	3,683	4,839
2.1/2"	63,50	1,323	1,669	2,613	3,884	5,107
2.5/8"	66,67	1,390	1,754	2,746	4,086	5,375
2.3/4"	69,85	1,457	1,839	2,880	4,288	5,644
3"	76,20	1,591	2,008	3,148	4,692	6,182

TUBOS - PESO POR METRO LINEAL

parte 2/2

Diámetro externo		Espesura da parede				
Pulgadas	Mm	1/32" 0,79mm	1,00mm	1/16" 1,58mm	3/32" 2,38mm	1/18" 3,17mm
3.1/4"	82,55	---	---	3,416	5,095	6,720
3.1/2"	88,90	---	---	3,684	5,499	7,257
3.3/4"	95,25	---	---	3,952	5,902	7,795
4"	101,60	---	---	4,220	6,306	8,332
4.1/4"	107,95	---	---	4,488	6,709	8,870
4.1/2"	114,30	---	---	4,756	7,113	9,407
4.3/4"	120,65	---	---	5,024	7,517	9,945
5"	127,00	---	---	5,292	7,920	10,482

CHAPAS - PESO POR PIEZA

(BWG)	Mm	1.200x 600mm	2.000x 1.000mm
---	25,40	155,45	431,80
---	22,22	135,99	377,74
---	19,05	116,59	323,85
---	15,87	97,12	269,79
---	12,70	77,72	215,90
---	9,52	58,26	161,84
---	7,93	48,53	134,81
---	6,35	38,86	107,95
---	4,76	29,13	80,92
---	3,97	24,30	67,49
10	3,40	20,81	57,80
---	3,17	19,40	53,89
11	3,04	18,60	51,68
12	2,77	16,95	47,09
13	2,41	14,75	40,97
14	2,11	12,91	35,87

(BWG)	Mm	1.200x 600mm	2.000x 1.000mm
15	1,83	11,20	31,11
16	1,65	10,10	28,05
17	1,47	9,00	24,99
18	1,24	7,59	21,08
19	1,07	6,55	18,19
20	0,89	5,45	15,13
21	0,81	4,96	13,77
22	0,71	4,35	12,07
23	0,64	3,92	10,88
24	0,56	3,43	9,52
25	0,51	3,12	8,67
26	0,46	2,82	---
27	0,41	2,51	---
28	0,36	2,20	---
30	0,30	1,84	---

accero
inoxidabile



Acero inoxidable

El acero inoxidable es una aleación de hierro y cromo, teniendo también níquel, molibdeno y otros elementos, que presentan propiedades físico-químicas superiores a los aceros comunes. Su principal característica es la resistencia a la oxidación. Algunas de sus características son:

- ▶ Resistencia a altas temperaturas;
- ▶ Facilidades de limpieza;
- ▶ Material higiénico;
- ▶ Alta resistencia a la corrosión;
- ▶ Durabilidad;
- ▶ 100% reciclable.

Los principales mercados que usan los aceros inoxidables, son: utensilios domésticos; equipos hospitalarios, producción de piezas para vehículos como, por ejemplo: tubos de escape; construcción; industria alimentaria, industria de productos químicos y de petróleo; y el sector de frentes y placas de señalización visual.

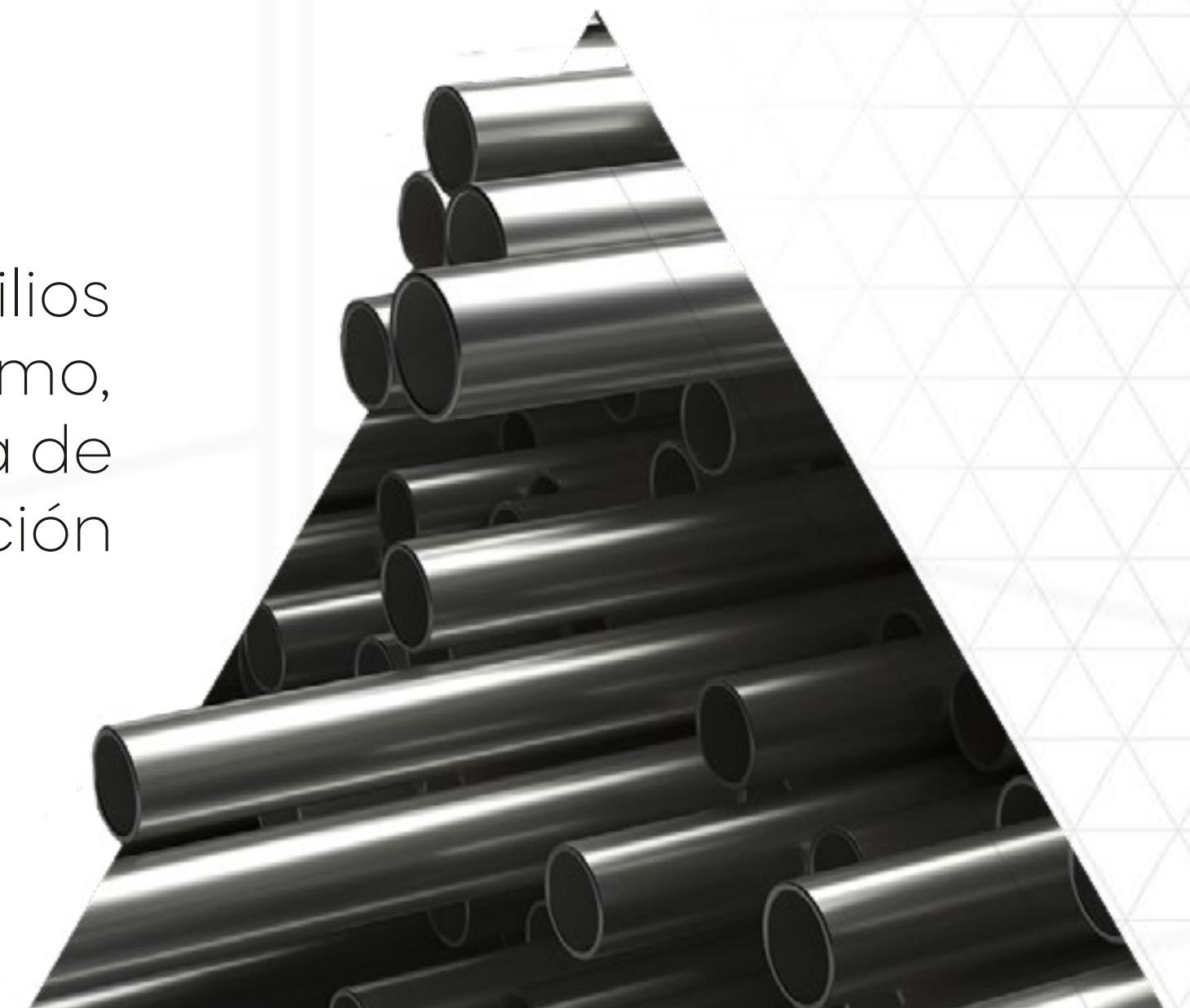













COMPOSICIÓN QUÍMICA Y MECÁNICA

	AISI	ASTM (UNSO)	DIN	EQUIVALENCIA DIN	C	Mn	Si	P	S	Cr	Ni	Mo	N2	Otros	Límite de resistencia (Mpa)	Límite de elasticidad (Mpa)	Alargamiento 50 mm (%)	DUREZA HBR ³
AUSTENÍTICOS	301	S30100	14,310	X12 Cr Ni 17 7	0.15	2.00	1.0	0.045	0.03	16,0 a 18,0	6,0 a 8,0	-	0.10	-	750	250	40	95
	304	S30400	14,301	X5 Cr Ni 18 9	0.07	2.00	0.75	0.045	0.03	17,5 a 19,5	8,0 a 10,5	-	0.10	-	700	300	54	92
	304	S30400	14,301	X5 Cr Ni 18 9	0.07	2.00	0.75	0.045	0.03	17,5 a 19,5	8,0 a 10,5	-	0.10	-	600	280	58	92
	304L	S30403	14,307	X2 Cr Ni 18 9	0.03	2.00	0.75	0.045	0.03	17,5 a 19,5	8,0 a 12,0	-	0.10	-	600	240	45	92
	304H	S30409	-	X5 Cr Ni 18 9	0,04 a 0,10	2.00	0.75	0.045	0.03	18,0 a 20,0	8,0 a 10,5	-	-	-	530	240	50	92
	310S	S31008	14,845	X8 Cr Ni 25 21	0.08	2.00	1.5	0.045	0.03	24,0 a 26,0	19,0 a 22,0	-	-	-	515	205	40	95
	316	S31600	14,401	X5 Cr Ni Mo 18 10	0.08	2.00	0.75	0.045	0.03	16,0 a 18,0	10,0 a 14,0	2,0 a 3,0	0.10	-	620	300	52	95
	316L	S31603	14,404	X5 Cr Ni Mo 18 10	0.03	2.00	0.75	0.045	0.03	16,0 a 18,0	10,0 a 14,0	2,0 a 3,0	0.10	-	530	260	45	95
	321	S32100	14,541	X10 Cr Ni Ti 18 9	0.08	2.00	0.75	0.045	0.03	17,0 a 19,0	9,0 a 12,0	-	0.10	5(C+N2)≤Ti≤ 0,70	530	240	40	95
	317L	S31703	-	X2 Cr Ni Mo 18 15 4	0.03	2.00	0.75	0.045	0.03	18,0 a 20,0	11,0 a 15,0	3,0 a 4,0	0.1	-	5515	205	40	95
	347/347H	S34709	-	X10 Cr Ni Mb 18 9	0,04 a 0,10	2.00	0.75	0.045	0.03	17 a 19,0	9,0 a 13,0	-	-	Nb 8xC min. 1,00 máx.	515	205	40	92
FERRIES	-	S41003	14,003	-	0.03	1.50	1.0	0.04	0.03	10,5 a 12,5	1.5	-	0.03	-	455	275	18	20 HRC
	409	S40910	14,512	X2 Cr Ti 12	0.03	1.00	1.0	0.04	0.02	10,50 a 11,7	0.50	-	0.030	6(C+N2)≤ Ti≤0,50	330	200	32	88
	430	S43003	14,016	X6 Cr 17	0.12	1.00	1.0	0.04	0.03	16,0 a 18,0	0.75	-	-	-	450	250	22	89
	-	S43000	14,016	-	0.12	1.00	1.0	0.04	0.03	16,0 a 18,0	0.75	-	-	Nb = 0,60 máx.	450	250	28	89
	-	S43932	-	-	0.03	1.00	1.0	0.04	0.03	17,0 a 19,0	0.50	-	0.030	0,20 + 4(C+N2) ≤ Ti + Nb ≤ 0,75	420	240	28	89
	-	-	14,509	-	0.03	1.00	1.0	0.04	0.015	17,5 a 18,5	0.50	-	0.030	3C + 0,30 ≤ Nb ≤ 1,00 Ti= 0,10 a 0,60	440	250	20	0
	-	S44400	-	-	0.025	1.00	1.0	0.04	0.03	17,5 a 19,5	1.00	1,75 a 2,50	0.035	0,20 + 4(C+N2) ≤ Ti + Nb ≤ 0,80	490	337	32	96
MAR-TENSÍTICOS	420	S42000	-	-	0,15 Min.	1.00	1.0	0.04	0.03	12,0 a 14,0	0.75	0.50	-	-	530	300	20	96
	-	-	14,116	-	0,42 a 0,47	0.50	0,30 a 0,70	0.035	0.006	14,0 a 14,5	-	0,50 a 0,55	0,020 a 0,040	V = 0,10 a 0,20	0	0	0	0
DUPLEX	-	S32304	14,362	-	0.03	2.50	1.0	0.04	0.03	21,5 a 24,5	3,0 a 5,5	0,05 a 0,6	0,05 a 0,020	-	600	400	25	32 HRC
	-	S32205/S31803	14,462	-	0.03	2.00	1.0	0.03	0.02	22,0 a 23,0	4,5 a 6,5	3,0 a 3,50	0,14 a 0,20	-	655	450	25	31 HRC
	201	S20100	14,618	-	0.15	5,50 a 7,50	1.0	0.06	0.03	16,0 a 18,0	3,5 a 5,5	-	0.25	-	515	260	40	95

BARRAS REDONDAS CUADRADAS HEXAGONALES

parte 1/2

Calibre		Kg/m			Calibre		Kg/m			Calibre		Kg/m			Calibre		Kg/m		
Pulgadas	mm				Pulgadas	mm				Pulgadas	mm				Pulgadas	mm			
1/8	3,17	0,062	-	-	1	31,75	3,97	5,06	4,38	1.15/16	49,21	14,92	18,99	16,45	2.7/8	73,02	32,85	41,82	36,22
5/32	3,97	0,097	-	-	1.1/16	31,75	4,49	5,71	4,95	2	50,8	15,9	20,24	17,53	2.15/16	74,61	34,29	43,66	37,81
3/16	4,76	0,140	0,18	0,15	1.1/8	31,75	5,03	6,4	5,55	2.1/16	53,39	16,91	21,52	18,64	3	76,20	35,77	45,54	39,43
1/4	6,35	0,25	0,32	0,27	1.3/16	31,75	5,60	7,14	6,18	2.1/8	53,97	17,95	22,85	19,79	3.1/8	79,38	38,81	49,41	42,79
5/196	7,94	0,39	0,49	0,43	1.1/4	31,75	6,21	7,91	6,85	2.3/16	55,56	19,02	24,21	20,97	3.1/4	82,55	41,88	53,44	46,34
3/8	9,53	0,56	0,71	0,62	1.5/16	31,75	6,85	8,72	7,55	2.1/4	57,15	20,12	25,62	22,19	3.3/8	85,73	42,27	57,63	49,98
7/16	11,11	0,76	0,97	0,84	1.3/16	31,75	7,51	9,57	8,29	2.6/16	58,74	21,25	27,06	23,44	3.1/2	88,90	48,68	61,98	53,74
1/2	12,7	0,99	1,22	1,10	1.7/16	31,75	8,21	10,46	9,06	2.3/8	60,32	22,42	28,54	24,72	3.5/8	92,08	52,22	66,49	-
9/16	14,29	1,26	1,60	1,39	1.1/2	31,75	8,94	11,39	9,86	2.7/16	61,91	23,61	30,06	26,03	3.3/4	95,25	55,88	71,15	-
5/8	15,87	1,55	1,98	1,71	1.9/16	31,75	9,70	12,35	10,7	2.1/2	63,50	24,84	31,62	27,38	3.7/8	94,43	60,67	75,98	-
11/16	17,46	1,88	2,36	2,07	1.5/8	31,75	10,49	13,36	11,57	2.9/16	65,09	26,10	33,22	28,78	4	101,6	63,58	80,96	-
3/4	19,05	2,24	2,85	2,46	1.11/16	31,75	11,32	14,41	12,48	2.5/8	66,67	27,38	34,87	30,79	4.1/8	104,78	67,62	86,10	-
13/16	20,64	2,62	3,34	2,89	1.3/4	31,75	12,17	15,5	13,42	2.11/16	68,26	28,70	36,55	31,67					
7/8	22,22	3,04	3,87	3,35	1.13/16	31,75	13,06	16,62	14,4	2.3/4	69,85	30,05	38,27	33,14					
15/16	23,81	3,49	4,45	3,85	1.7/8	31,75	13,97	17,79	15,41	2.13/16	71,44	31,44	40,02	34,22					

BARRAS REDONDAS CUADRADAS HEXAGONALES

parte 2/2

Calibre		Kg/m			Calibre		Kg/m			Calibre		Kg/m			Calibre		Kg/m		
Pul-ga-das	mm				Pul-ga-das	mm				Pul-ga-das.	mm				Pul-ga-das.	mm			
4.1/4	107,95	71,78	91,39	-	7.1/4	184,15	209,70	266,20	-	11	279,40	481,20	612,80	-	19	482,60	1434,60	1826,60	-
4.3/8	111,13	76,06	96,85	-	7.1/2	190,50	223,80	285,00	-	11.1/4	285,75	503,40	641,00	-	20	508,00	1589,50	2023,90	-
4.1/2	114,30	80,47	102,46	-	7.3/4	196,85	238,90	304,00	-	11.1/2	292,70	526,00	669,80	-	21	533,40	1752,61	2230,60	-
4.5/8	117,48	85,01	108,23	-	8	203,20	254,60	324,00	-	11.3/4	298,45	549,00	699,20	-	22	558,80	1932,50	2448,09	-
4.3/4	120,65	89,66	114,16	-	8.1/4	209,55	270,70	345,00	-	12	304,80	572,70	729,30	-	23	584,20	2102,34	2675,71	-
4.7/8	123,83	94,44	120,25	-	8.1/2	215,90	287,40	365,90	-	12.1/2	317,50	620,90	790,60	-	24	609,60	2289,13	2913,43	-
5	127,00	99,80	126,50	-	8.3/4	222,25	304,60	388,50	-	13	330,20	672,60	855,80	-	25	635,00	2483,86	3161,28	-
5.1/4	133,35	109,50	139,50	-	9	228,60	322,10	410,20	-	13.1/2	342,90	724,30	922,20	-	26	660,40	2686,54	3419,24	-
5.1/2	139,70	120,20	153,10	-	9.1/4	234,95	340,30	433,50	-	14	355,60	779,70	992,60	-	27	685,80	2897,18	3687,32	-
5.3/4	146,05	131,40	167,20	-	9.1/2	241,30	359,00	457,10	-	14.1/2	368,30	835,50	1063,80	-	28	711,20	3115,76	3965,51	-
6	152,40	143,10	182,50	-	9.3/4	247,65	378,10	481,40	-	15	381,00	894,90	1139,50	-	29	736,60	3342,29	4253,82	-
6.1/4	158,75	155,20	197,80	-	10	254,00	397,80	506,50	-	15.1/2	393,70	954,70	1215,60	-	30	762,00	3576,76	4552,24	-
6.1/2	165,10	167,90	213,50	-	10.1/4	260,35	417,90	532,00	-	16	406,50	1017,30	1295,30	-					
6.3/4	171,45	181,10	231,00	-	10.1/2	266,70	438,50	558,40	-	17	431,80	1148,60	1462,30	-					

Calibre	Kg/m	Calibre	Kg/m
1/8" x 3/4"	0,86	1/4" x 1.1/4"	2,86
1/8" x 1"	1,27	1/4" x 1.1/2"	3,48
1/8" x 1.1/4"	1,52	1/4" x 2"	4,75
1/8" x 1.1/2"	1,83	1/4" x 2.1/2"	6,10
1/8" x 2"	2,46	1/4" x 3"	7,29
3/16" x 1"	1,73	5/16" x 2"	5,83
3/16" x 1.1/4"	2,19	5/16" x 3"	8,99
3/16" x 1.1/2"	2,66	3/8" x 2"	6,99
3/16" x 2"	3,63	3/8" x 2.1/2"	8,78
3/16" x 2.1/2"	4,57	3/8" x 3"	10,69
1/4" x 1"	2,24	3/8" x 4"	14,41

BARRAS RECTANGULARES

parte 1/1

Calibre	Kg/m	Calibre	Kg/m	Calibre	Kg/m	Calibre	Kg/m	Bitola	Kg/m
1/8" x 3/4"	0,47	1/4" x 1.1/2"	1,89	3/8" x 2"	3,79	5/8" x 2.1/2"	7,91	1.1/4" x 3"	18,87
1/8" x 1"	0,63	1/4" x 2"	2,53	3/8" x 2.1/2"	4,74	5/8" x 3"	9,48	1.1/4" x 4"	23,30
1/8" x 1.1/4"	0,79	1/4" x 2.1/2"	3,16	3/8" x 3"	5,69	5/8" x 4"	12,65	1.1/2" x 4"	15,20
1/8" x 1.1/2"	0,94	1/4" x 3"	3,79	3/8" x 4"	7,60	3/4" x 1"	3,80	1.1/2" x 2"	22,80
1/8" x 2"	1,26	1/4" x 4"	5,06	1/2" x 3/4"	1,90	3/4" x 1.1/4"	4,75	1.1/2" x 3"	30,40
1/8" x 3"	1,90	5/16" x 3/4"	1,20	1/2" x 1"	2,53	3/4" x 1.1/2"	5,70	2" x 3"	30,30
1/8" x 4"	2,54	5/16" x 1"	1,58	1/2" x 1.1/4"	3,16	3/4" x 2"	7,59		
3/16" x 3/4"	0,71	5/16" x 1.1/4"	1,97	1/2" x 1.1/2"	3,79	3/4" x 2.1/2"	9,48		
3/16" x 1"	0,94	5/16" x 1.1/2"	2,37	1/2" x 1.3/4"	4,42	3/4" x 3"	11,58		
3/16" x 1.1/4"	1,18	5/16" x 2"	3,16	1/2" x 2"	5,06	3/4" x 4"	15,18		
3/16" x 1.1/2"	1,42	5/16" x 2.1/2"	4,00	1/2" x 2.1/2"	6,32	1" x 1.1/2"	7,59		
3/16" x 2"	1,89	5/16" x 3"	4,80	1/2" x 3"	7,59	1" x 1.3/4"	8,86		
3/16" x 3"	2,85	5/16" x 4"	6,33	1/2" x 4"	10,10	1" x 2"	10,12		
3/16" x 4"	3,80	3/8" x 3/4"	1,42	5/8" x 1"	3,16	1" x 2.1/2"	12,65		
1/4" x 3/4"	0,94	3/8" x 1"	1,98	5/8" x 1.1/4"	3,95	1" x 3"	15,18		
1/4" x 1"	1,26	3/8" x 1.1/4"	2,37	5/8" x 1.1/2"	4,74	1" x 4"	20,24		
1/4" x 1.1/4"	1,58	3/8" x 1.1/2"	2,84	5/8" x 2"	6,32	1.1/4" x 2"	12,65		

Espesor N° (USG)	mm	Peso por m ²	Peso teórico por chapas				
			2 x 1 m	2 x 1,2 m	3 x 1 m	3 x 1,2 m	3 x 1,5 m
-	50,80	406,40	812,80	975,36	1219,20	1463,04	1828,8
-	44,45	355,60	711,20	853,44	1066,80	1280,16	1600,20
-	38,10	304,80	609,60	731,52	914,40	1097,28	1371,60
-	31,75	254,00	508,00	609,60	762,00	914,40	1143,00
-	25,40	202,27	405,00	486,00	607,00	728,00	910,00
-	22,22	176,99	354,00	425,00	531,00	637,00	796,00
-	19,05	152,40	304,80	365,76	457,20	548,64	685,80
-	15,87	136,43	273,00	327,00	410,00	491,00	614,00
-	12,70	101,13	203,00	243,00	304,00	364,00	455,00
-	11,11	88,49	177,00	212,00	566,00	318,00	398,00
-	9,53	75,84	152,00	182,00	228,00	273,00	341,00
-	7,93	63,20	127,00	152,00	190,00	227,00	284,00
3	6,35	53,50	107,00	128,00	161,00	192,00	240,00
5	5,66	44,24	89,00	106,00	133,00	159,00	199,00
7	4,76	37,92	76,00	91,00	114,00	136,00	170,00

Espesor N° (USG)	mm	Peso por m ²	Peso teórico por chapas				
			2 x 1 m	2 x 1,2 m	3 x 1 m	3 x 1,2 m	3 x 1,5 m
8	4,37	35,32	71,00	85,00	106,00	127,00	159,00
9	3,97	32,10	65,00	77,00	97,00	115,00	144,00
10	3,57	28,90	58,00	69,00	86,00	104,00	130,00
11	3,18	25,66	52,00	62,00	77,00	92,00	115,00
12	2,78	22,48	45,00	54,00	67,00	81,00	101,00
13	2,37	19,27	38,00	46,00	57,00	69,00	86,00
14	1,98	15,80	32,00	38,00	48,00	57,00	71,00
15	1,79	14,44	29,00	35,00	43,00	52,00	65,00
16	1,56	12,24	25,00	30,00	37,00	44,00	55,00
17	1,43	11,56	23,00	28,00	35,00	41,00	52,00
18	1,27	10,27	20,50	25,00	30,80	36,90	46,00
19	1,11	8,99	18,00	22,00	27,00	32,30	40,00
20	0,95	7,71	15,40	18,00	23,10	27,70	34,60
21	0,87	7,06	14,10	17,00	21,20	25,40	31,70
22	0,79	6,42	12,80	15,00	19,30	23,10	27,90

Espesor N° (USG)	mm	Peso por m ²	Peso teórico por chapas				
			2 x 1 m	2 x 1,2 m	3 x 1 m	3 x 1,2 m	3 x 1,5 m
23	0,71	5,77	11,60	14,00	17,30	20,70	25,90
24	0,64	5,14	10,30	12,00	15,40	18,50	23,10
25	0,56	4,49	9,00	11,00	13,50	16,20	20,20
26	0,46	3,85	7,70	9,00	11,60	13,90	17,30
27	0,44	3,63	7,00	8,70	10,60	13,10	16,30
28	0,40	3,20	6,40	7,70	9,60	11,50	14,40

TUBOS CUADRADOS Y RECTANGULARES

parte 1/2

Medidas externas (mm)		Espesor de pared - mm							
Cuadrado	Rectangular	1,0	1,2	1,5	2,0	2,5	2,8	3,8	3,5
15 x 15	10 x 20	0,5	0,6	0,7	-	-	-	-	-
20 x 20	15 x 25	0,6	0,7	0,9	1,2	-	-	-	-
25 x 25	15 x 35	0,8	0,9	1,1	1,5	1,8	-	-	-
	20 x 30								
-	20 x 35	0,8	1,0	1,2	1,6	2,0	2,1	2,4	-
30 x 30	20 x 40	0,9	1,1	1,4	1,8	2,2	2,4	2,6	-
	25 x 35								
35 x 35	20 x 50	1,1	1,3	1,6	2,1	2,6	2,8	3,1	-
	30 x 40								
-	25 x 50	1,2	1,4	1,7	2,3	2,8	3,0	3,3	-
	30 x 50								
40 x 40	20 x 70	1,4	1,7	2,1	2,7	3,4	3,0	4,0	-
	30 x 60								
	40 x 50								



TUBOS CUADRADOS Y RECTANGULARES

parte 2/2

Medidas externas (mm)		Espesor de pared - mm							
Cuadrado	Rectangular								
-	25 x 70	1,5	1,8	2,2	2,9	3,6	3,7	4,2	4,9
	35 x 60								
50x 50	30 x 70	-	1,8	2,3	3,0	3,8	4,1	4,5	5,2
60 x 60	30 x 90	-	2,2	2,8	3,7	4,5	5,0	5,4	6,3
	40 x 80								
	50 x 70								
70 x 70	40 x 100	-	2,6	3,2	4,3	5,3	6,0	6,4	7,6
	50 x 90								
	60 x 80								
80 x 80	60 x 100	-	3,0	3,7	4,9	6,1	6,8	7,4	8,7
-	100 x 50	-	-	3,5	4,7	5,8	-	7,0	-
90 x 90	100 x 80	-	-	-	5,6	7,0	-	8,4	-
100 x 100	120 x 80	-	-	-	6,3	7,8	-	9,4	-

ACERO CORRUGADO PESO/METRO

parte 2/3

Pulgada	Milímetro			
8"	203,20	4,205	---	---
9"	228,60	4,827	---	---
10"	254,00	5,493	---	---
11"	279,40	6,200	---	---
13"	330,20	6,952	---	---

ÁNGULOS - SOLAPAS IGUALES (PESO/METRO)

parte 1/2

Ancho/espesor		1/16" 1,58 mm	3/32" 2,38 mm	1/8" 3,17 mm	3/16" 4,76 mm	1/4" 6,35 mm	1/2" 12,70 mm
1/2"	12,70	0,102	0,148	0,191	---	---	---
5/8"	15,87	0,129	---	0,245	---	---	---
3/4"	19,05	0,156	0,230	0,300	---	---	---
7/8"	22,22	---	0,271	0,355	---	---	---
1"	25,40	0,211	0,312	0,409	0,594	0,765	---
1.1/4"	31,75	---	---	0,518	0,758	---	---

ÁNGULOS - SOLAPAS IGUALES (PESO/METRO)

parte 2/2

Ancho/espesor		1/16" 1,58 mm	3/32" 2,38 mm	1/8" 3,17 mm	3/16" 4,76 mm	1/4" 6,35 mm	1/2" 12,70 mm
1.1/2"	38,10	0,320	---	0,627	0,922	1,202	---
2"	50,80	---	0,640	0,846	1,249	1,639	---
2.1/2"	63,50	---	---	1,064	---	2,076	---
3"	76,20	---	---	1,282	1,904	2,513	---
4"	101,60	---	---	1,718	---	3,387	6,556

BARRA CHATA (PESO/METRO)

parte 1/2

Ancho/espesor		1/8" 3,17 mm	3/16" 4,76 mm	1/4" 6,35 mm	3/8" 9,53 mm	1/2" 12,70 mm	5/8" 15,87 mm	3/4" 19,05 mm	1" 25,40 mm
3/8"	9,53	0,082	---	0,164	---	---	---	---	---
1/2"	12,70	0,109	0,164	0,219	0,328	---	---	---	---
5/8"	15,87	0,136	0,205	0,273	0,410	---	---	---	---
3/4"	19,05	0,164	0,246	0,328	0,492	0,656	---	---	---
7/8"	22,22	0,191	0,287	0,382	---	---	---	---	---

BARRA CHATA (PESO/METRO)

parte 2/2

Ancho/espesor		1/8" 3,17 mm	3/16" 4,76 mm	1/4" 6,35 mm	3/8" 9,53 mm	1/2" 12,70 mm	5/8" 15,87 mm	3/4" 19,05 mm	1" 25,40 mm
1"	25,40	0,218	0,328	0,437	0,656	0,874	1,092	1,311	---
1.1/4"	31,75	0,273	0,410	0,546	0,820	1,093	---	---	---
1.1/2"	38,10	0,327	0,491	0,656	0,984	1,311	1,639	1,967	2,623
2"	50,80	0,436	0,655	0,874	1,312	1,748	2,185	2,623	3,497
2.1/2"	63,50	0,546	0,819	1,093	1,640	2,185	3,277	3,278	---
3"	76,20	0,655	0,983	1,311	1,968	2,623	4,370	3,934	5,245
4"	101,60	0,873	1,311	1,748	2,624	3,497	5,462	5,245	6,994
5"	127,00	---	1,638	2,185	3,280	4,371	---	6,556	8,742
6"	152,40	---	---	2,623	3,936	5,245	---	7,868	10,490

TUBO REDONDO (PESO/METRO)

parte 1/2

Diámetro externo		Espesor de la pared					
Pulgada	Milímetro	1/32" 0,79 mm	1,00 mm	1/16" 1,58 mm	2,00 mm	3/32" 2,38 mm	1/8" 3,17 mm
3/8"	9,53	0,059	0,073	0,107	---	---	---
1/2"	12,70	0,080	0,100	0,150	0,182	---	0,257
5/8"	15,87	0,101	0,127	0,192	0,236	0,273	0,343
3/4"	19,05	0,123	0,154	0,235	0,290	0,338	0,429
7/8"	22,22	0,144	0,181	0,278	0,344	0,402	0,514
1"	25,40	0,166	0,208	0,320	0,398	0,466	0,600
1.1/8"	28,57	0,187	0,235	0,363	---	---	0,686
1.1/4"	31,75	0,208	0,262	0,406	0,507	0,595	0,771
1.3/8"	34,93	0,230	---	0,449	---	---	---
1.1/2"	38,10	0,251	0,316	0,491	0,615	0,724	0,943
1.5/8"	41,27	0,272	---	0,534	0,669	0,788	---
1.3/4"	44,45	0,294	---	0,577	0,723	0,852	1,114
1.7/8"	47,62	0,315	---	0,619	0,777	---	---
2"	50,80	0,336	---	0,662	0,831	0,981	1,285

TUBO REDONDO (PESO/METRO)

Diámetro externo		Espesor de la pared					
Pulgada	Milímetro	1/32" 0,79 mm	1,00 mm	1/16" 1,58 mm	2,00 mm	3/32" 2,38 mm	1/8" 3,17 mm
2.1/4"	57,15	0,379	---	0,748	---	---	1,457
2.3/8"	60,32	0,400	---	0,790	---	---	---
2.1/2"	63,50	0,422	---	0,833	1,047	1,238	1,628
2.3/4"	69,85	0,464	---	---	---	---	1,800
3"	76,20	0,507	---	1,004	1,263	1,496	1,971
3.1/4"	82,55	0,550	---	---	---	---	2,142
3.1/2"	88,90	0,593	---	---	1,480	---	2,314
4"	101,60	0,678	---	---	1,696	2,010	2,656
4.1/2"	114,30	0,763	---	---	---	---	2,999
5"	127,00	0,849	---	---	2,128	---	3,342
5.1/2"	139,70	0,934	---	---	---	---	3,685
6"	152,40	1,020	---	---	2,561	---	4,028

TUBO SCHEDULE 40 (PESO/METRO)

Diámetro nominal (pulgadas)	Diámetro externo (milímetro)	Diámetro interno (milímetro)	Espesor de la pared (milímetros)	Peso/ metro
3/8"	17,15	12,52	2,31	0,292
1/2"	21,34	15,80	2,77	0,438
3/4"	26,67	20,93	2,87	0,582
1"	33,40	26,64	3,38	0,864
1.1/4"	42,16	35,05	3,56	1,170
1.1/2"	48,26	40,90	3,68	1,397
2"	60,33	52,51	3,91	1,878
2.1/2"	73,03	62,71	5,16	2,982
3"	88,90	77,92	5,49	3,899
3.1/2"	101,60	90,12	5,74	4,685
4"	114,30	102,26	6,02	5,550
4.1/2"	127,00	114,46	6,27	6,445
5"	141,30	128,20	6,55	7,514
6"	168,28	154,05	7,11	9,756

galuminio

TUBO SCHEDULE 80 (PESO/METRO)

Diámetro nominal (pulgadas)	Diámetro externo (milímetro)	Diámetro interno (milímetro)	Espesor de la pared (milímetros)	Peso/ metro
3/8"	17,15	10,74	3,20	0,380
1/2"	21,34	13,87	3,73	0,559
3/4"	26,67	18,85	3,91	0,758
1"	33,40	24,31	4,55	1,118
1.1/4"	42,16	32,46	4,85	1,541
1.1/2"	48,26	38,10	5,08	1,868
2"	60,33	49,25	5,54	2,584
2.1/2"	73,03	59,00	7,01	3,940
3"	88,90	73,66	7,62	5,273
3.1/2"	101,60	85,45	8,08	6,433
4"	114,30	97,18	8,56	7,706
5"	141,30	122,25	9,53	10,691
6"	168,28	146,33	10,97	14,692

TUBO CUADRADO (PESO/METRO)

Diámetro externo		Espesor de la pared			
Pulgada	Milímetro	1,00 mm	1/16" 1,58 mm	2,00 mm	1/8" 3,17 mm
1/2"	12,70	---	0,190	---	---
5/8"	15,87	---	0,245	---	---
3/4"	19,05	0,196	0,299	0,370	0,546
1"	25,40	---	0,408	0,507	0,764
1.1/4"	31,75	---	0,517	0,645	---
1.1/2"	38,10	---	0,625	0,783	---
2"	50,80	---	---	1,058	1,637
2.1/2"	63,50	---	---	---	2,073
3"	76,20	---	---	---	---
4"	101,60	---	---	---	---

TUBO RECTANGULAR (PESO/METRO)

Dimensión				Espesor de la pared	
Base		Altura			
Pulgada	Milímetro	Pulgada	Milímetro	1/16" 1,58 mm	2,00 mm
1"	25,40	1/2"	12,70	0,299	---
1.1/2"	38,10	1"	25,40	0,517	0,645
2"	50,80	1/2"	12,70	0,517	---
2"	50,80	1"	25,40	0,625	0,783
2"	50,80	1.1/2"	38,10	---	0,920
3"	76,20	1"	25,40	0,843	1,054
3"	76,20	1.1/2"	38,10	0,952	1,196
4"	101,60	1.1/2"	38,10	---	1,471
4"	101,60	2"	50,80	---	1,609
5"	127,00	2"	50,80	---	1,884
6"	152,40	1.1/2"	38,10	---	---
6"	152,40	3"	76,20	---	---

LIGA 2011
PERFIL "T" (PESO/METRO)

PERFIL "U" SOLAPAS IGUALES (PESO/METRO)

Lado (L)		Espesor (E)		
Pulgada	mm	1/16" 1,58 mm	1/8" 3,17 mm	3/16" 4,76 mm
1/2"	12,70	---	0,191	---
5/8"	15,87	---	0,245	---
3/4"	19,05	0,156	0,299	---
7/8"	22,22	---	0,353	---
1"	25,40	0,210	0,408	---
1.1/4"	31,75	---	0,516	0,755
1.1/2"	38,10	---	0,625	0,918
2"	50,80	---	0,842	---

Lado (L)		Espesor (E)		
Pulgada	mm	1/16" 1,58 mm	3/32" 2,38 mm	1/8" 3,17 mm
3/8"	9,53	0,108	---	0,190
1/2"	12,70	0,149	0,214	0,272
5/8"	15,87	0,190	---	0,353
3/4"	19,05	0,230	0,337	0,435
7/8"	22,22	---	0,398	0,516
1"	25,40	---	0,459	0,598
1.1/4"	31,75	---	---	0,761
1.1/2"	38,10	---	---	0,924

LIGA 2011

PERFIL "U" SOLAPAS DESIGUALES (PESO/METRO)

Base (B)		Altura (A)	
Pulgadas	mm	Pulgadas	mm
3/8"	9,53	1/2"	12,70
1/2"	12,70	3/8"	9,53
5/8"	15,87	1"	25,40
5/8"	15,87	3/8"	9,53
3/4"	19,05	1/2"	12,70
3/4"	19,05	3/8"	9,53
3/4"	19,05	1/2"	12,70
1"	25,40	3/8"	9,53
1"	25,40	1/2"	12,70
1.1/2"	38,10	1/2"	12,70
2"	50,80	1"	25,40
3"	76,20	1"	25,40
4"	101,60	1.1/2"	38,10
4"	101,60	2"	50,80

Espesor (E)		
1/16" 1,58 mm	3/32" 2,38 mm	1/8" 3,17 mm
0,135	---	---
0,122	---	---
0,271	---	---
---	0,194	---
0,176	---	---
---	0,214	---
---	0,255	---
---	---	0,326
---	---	0,381
---	0,377	---
---	---	0,815
---	---	1,033
---	---	---
---	---	---

adipiscing elit
consequat



Acero al carbono (ferrosos)

El acero al carbono puede variar en el contenido de este elemento, lo que implica directamente en sus funciones como materia prima. Se subdivide como abajo, para diferentes aplicaciones. Compruebe:

Bajo carbono: Até 0,30% de carbono na composição.



Tiene baja resistencia y dureza, alta tenacidad y ductilidad, utilizable y soldable y bajo costo de producción.

Aplicaciones: chapas automotrices, perfiles estructurales, placas para la producción de tubos, construcción de edificios, puentes y latas de láminas de aluminios.

Carbono medio: De 0,30% a 0,60% de carbono en la composición



Mayor resistencia y dureza, menor tenacidad y ductilidad que el bajo carbono.

Presentan cantidad de carbono que permite recibir tratamiento térmico de temple y revenido.

Aplicaciones: ruedas y equipos ferroviarios, engranajes, cigüeñales y otras piezas de maquinaria, que requieran altas resistencias mecánicas y al desgaste y tenacidad.

Alto carbono: De 0,60% a 1% de carbono en composición



Posee mayor resistencia y dureza y menor ductilidad entre los aceros carbono. En la mayoría de las veces son templados o revenidos.

Aplicações: tableros, hojas de sierra, martillos y cuchillos

Formato	Ligas	Acabamento
Bobina	SAE-1006 a 1045, EM, EP, EEP, LN28, LNE26, LNE38, entre otros	Laminado en frío
Bobina	SAE-1006 a 1045, EM, EP, EEP, LN28, LNE26, LNE38, entre otros	Laminado en caliente
Planchas/placas	A36, A283C, A285C, A516G 60/70, CO-AR-COR 500, COSAR 50/60, SAC-50, SAR-60, RST-37.2, RTS-52-3, COMERCIAL, entre otros	Laminado en frío
Planchas/placas	A36, A283C, A285C, A516G 60/70, CO-AR-COR 500, COSAR 50/60, SAC-50, SAR-60, RST-37.2, RTS-52-3, COMERCIAL, entre otros	Laminado en caliente
Bobina ajedrez	A36, A283C, A285C, A516G 60/70, CO-AR-COR 500, COSAR 50/60, SAC-50, SAR-60, RST-37.2, RTS-52-3, COMERCIAL, entre otros	
Plancha/placa ajedrez	A36, A283C, A285C, A516G 60/70, CO-AR-COR 500, COSAR 50/60, SAC-50, SAR-60, RST-37.2, RTS-52-3, COMERCIAL, entre otros	
Plancha/placa	A36, A283C, A285C, A516G 60/70, CO-AR-COR 500, COSAR 50/60, SAC-50, SAR-60, RST-37.2, RTS-52-3, COMERCIAL, entre otros	
Perfil L	A36 e ASTM A572 G50 ou G60	
Perfil W	ASTM A572 GRAU 50	
Perfis I/U	A36 / ASTM A572	
Barra redonda	SAE 5160	Laminada/Trefilada
Barra redonda	SAE 1020 / SAE 1045 / SAE 1060 / SAE 4140 / SAE 4340 / SAE 8620	Laminada/Trefilada

Formato	Ligas	Acabamento
Barra cuadrada	SAE 1020 / SAE 1045 / SAE 1060 / SAE 4140 / SAE 4340 / SAE 8620	Laminada/Trefilada
Barra hexagonal	SAE 1020 / SAE 1045 / SAE 1060 / SAE 4140 / SAE 4340 / SAE 8620	Laminada/Trefilada
Barra plana	ASTM A36 / SAE 1020 / SAE 1045	
Tubo	API 5L / NBR 5580 (DIN2440) / NBR 5590/ NBR 6591 / ASTM A-53 / ASTM A-106 / ASTM A-333 / ASTM A 178 Grau A / ASTM A 135 / ASTM A 214 (NBR 5585)	Con soldadura
Tubo	API 5L / NBR 5580 (DIN2440) / NBR 5590/ NBR 6591 / ASTM A-53 / ASTM A-106 / ASTM A-333 / ASTM A 178 Grau A / ASTM A 135 / ASTM A 214 (NBR 5585)	Sin soldadura

COMPOSICIÓN QUÍMICA DEL ACERO AL CARBONO

parte 1/6

Norma	Acero	Composición Química %								
		C	Mn	P. máx	S. Máx	Si	Ni	Cr	Mo	Cu
5590 (ASTM A53)	GrA	Máx 0,25	Máx 0,95	0.05	0.045	-	Máx 0,40	Máx 0,40	0.15	Máx 0,40
	GrB	Máx 0,30	Máx 1,20	0.05	0.045	-	Máx 0,40	Máx 0,40	0.15	Máx 0,40
A 106	GrA	Máx 0,25	0,27/0,93	0.035	0.035	-	Máx 0,40	Máx 0,40	0.15	Máx 0,40
	GrB	Máx 0,30	0,29/1,06	0.035	0.035	Mín 0,10	Máx 0,40	Máx 0,40	0.15	Máx 0,40
	GrC	Máx 0,35	0,29/1,06	0.035	0.035	Mín 0,10	Máx 0,40	Máx 0,40	0.15	Máx 0,40
A 161	GrLC	0,10/0,20	0,30/0,80	0.035	0.035	Mín 0,10	-	-	-	-
	GrT1	0,10/0,20	0,30/0,80	0.025	0.025	Máx 0,25	-	-	0,44/0,65	-
A 178	GrA	0,06/0,18	0,27/0,63	0.035	0.035	0,10/0,50	-	-	-	-
	GrC	Máx 0,35	Máx 0,80	0.035	0.035	-	-	-	-	-
	SAC 50	Máx 0,18	Máx 1,40	0.03	0.015	-	-	-	-	-
A 179	A 179	0,06/0,18	0,27/0,63	0.035	0.035	Mín 0,10	-	-	-	-
A 192	A 192	0,06/0,18	0,27/0,63	0.035	0.035	-	-	-	-	-
A 199/200	GrT5	Máx 0,15	0,30/0,60	0.025	0.025	Máx 0,25	-	4,00/6,00	0,45/0,65	-
	GrT11	0,05/0,15	0,30/0,60	0.025	0.025	Máx 0,50	-	1,00/1,50	0,44/0,65	-
	GrT22	0,05/0,15	0,30/0,60	0.025	0.025	0,50/1,00	-	1,90/2,60	0,87/1,13	-

COMPOSICIÓN QUÍMICA DEL ACERO AL CARBONO

parte 2/6

Norma	Acero	Composición Química %								
		C	Mn	P. máx	S. Máx	Si	Ni	Cr	Mo	Cu
A 209	GrT1	0,10/0,20	0,30/0,80	0.025	0.025	Máx 0,50	-	-	0,44/0,65	-
	GrT1a	0,15/0,25	0,30/0,80	0.025	0.025	0,10/0,50	-	-	0,44/0,65	-
	GrT1b	Máx 0,14	0,30/0,80	0.025	0.025	0,10/0,50	-	-	0,44/0,65	-
A 210	GrA1	Máx 0,27	Máx 0,93	0.035	0.035	0,10/0,50	-	-	-	-
	GrC	Máx 0,35	0,29/1,06	0.035	0.035	Mín 0,10	-	-	-	-
A 213	GrT2	0,10/0,20	0,30/0,61	0.025	0.025	Mín 0,10	-	0,50/0,81	0,44/0,65	-
	GrT5	Máx 0,15	0,30/0,60	0.025	0.025	0,10/0,30	-	4,00/6,00	0,45/0,65	-
	GrT11	0,05/0,15	0,30/0,60	0.025	0.025	Máx 0,50	-	1,00/1,50	0,44/0,65	-
	GrT12	0,05/0,15	0,30/0,60	0.025	0.025	0,50/1,00	-	0,80/1,25	0,44/0,65	-
	GrT22	0,05/0,15	0,30/0,60	0.025	0.025	Máx 0,50	-	1,90/2,60	0,87/1,13	-
A 214	A 214	Máx 0,18	0,27/0,63	0.035	0.035	Máx 0,50	-	-	-	-
A 226	A 226	0,06/0,18	0,27/0,63	0.035	0.035	-	-	-	-	-
A 333/334	Gr1	Máx 0,30	0,40/1,06	0.025	0.025	Máx 0,25	-	-	-	-
	Gr3	Máx 0,19	0,31/0,64	0.025	0.025	-	3,18/3,82	-	-	-
	Gr6	Máx 0,30	0,29/1,06	0.025	0.025	0,18/0,37	-	-	-	-
	Gr7	Máx 0,19	Máx 0,90	0.025	0.025	Mín 0,10	2,03/2,57	-	-	-

COMPOSICIÓN QUÍMICA DEL ACERO AL CARBONO

parte 3/6

Norma	Acero	Composición Química %								
		C	Mn	P. máx	S. Máx	Si	Ni	Cr	Mo	Cu
A 335	GrP1	0,10/0,20	0,30/0,80	0.025	0.025	0,13/0,32	-	-	0,44/0,65	-
	GrP2	0,10/0,20	0,30/0,61	0.025	0.025	0,10/0,50	-	0,50/0,81	0,44/0,65	-
	GrP5	Máx 0,15	0,30/0,60	0.025	0.025	0,10/0,30	-	4,00/6,00	0,45/0,65	-
	GrP11	0,05/0,15	0,30/0,60	0.025	0.025	Máx 0,50	-	1,00/1,50	0,44/0,65	-
	GrP12	0,05/0,15	0,30/0,61	0.025	0.025	0,50/1,00	-	0,80/1,25	0,44/0,65	-
	GrP22	0,05/0,15	0,30/0,60	0.025	0.025	Máx 0,50	-	1,90/2,60	0,87/1,13	-
A 423	Gr1	Máx 0,15	Máx 0,55	0,06/0,16	0.06	Máx 0,50	0,20/0,70	0,24/1,31	-	0,20/0,60
	Gr2	Máx 0,15	0,50/1,00	0.04	0.05	Mín 0,10	0,40/1,10	-	Mín 0,10	0,30/1,00
A 500	GrA	Máx 0,30	-	0.05	0.063	-	-	-	-	Mín 0,18
	GrB	Máx 0,30	-	0.05	0.063	-	-	-	-	Mín 0,18
	GrC	Máx 0,27	Máx 1,40	0.05	0.063	-	-	-	-	Mín 0,18
A 501	A 501	Máx 0,30	-	0.05	0.063	-	-	-	-	-
DIN 1626	St 37.0	Máx 0,17	-	0.04	0.04	-	-	-	-	-

COMPOSICIÓN QUÍMICA DEL ACERO AL CARBONO

parte 4/6

Norma	Acero	Composición Química %								
		C	Mn	P. máx	S. Máx	Si	Ni	Cr	Mo	Cu
DIN 1629	St 44.0	Máx 0,21	-	0.04	0.04	-	-	-	-	-
	St 52.0	Máx 0,22	Máx 1,60	0.04	0.035	-	-	-	-	-
DIN 2391	St 35.0	Máx 0,17	Mín 0,40	0.05	0.05	Máx 0,80	-	-	-	-
	St 45.0	Máx 0,21	Mín 0,40	0.05	0.05	Máx 0,35	-	-	-	-
	St 52.0	Máx 0,22	Máx 1,60	0.05	0.05	Máx 0,35	-	-	-	-
	VMec 134AP	Máx 0,22	Máx 1,60	0.04	0,010/0,030	Máx 0,55	-	-	-	-
DIN 2393	St 34.2	Máx 0,15	-	0.05	0.05	Máx 0,55	-	-	-	-
	St 37.2	Máx 0,18	-	0.05	0.05	-	-	-	-	-
	St 42.0	Máx 0,25	-	0.05	0.05	Máx 0,55	-	-	-	-
	St 52.3	Máx 0,22	Máx 1,60	0.05	0.05	-	-	-	-	-
DIN 17175	VMec 134AP	Máx 0,22	Máx 1,60	0.025	0.025	-	-	-	-	-
	St 35.8	Máx 0,17	0,40/0,80	0.04	0.04	Máx 0,55	-	-	-	-
	St 45.8	Máx 0,21	0,40/1,20	0.04	0.04	0,10/0,35	-	-	-	-

COMPOSICIÓN QUÍMICA DEL ACERO AL CARBONO

parte 5/5

Norma	Acero	Composición Química %								
		C	Mn	P. máx	S. Máx	Si	Ni	Cr	Mo	Cu
DIN 17175	15Mo3	0,12/0,20	0,40/0,80	0.035	0.035	0,10/0,35	-	-	-	-
	13CrMo44	0,10/0,18	0,40/0,70	0.035	0.035	0,10/0,35	-	-	-	-
	10CrMo910	0,08/0,15	0,40/0,70	0.035	0.035	0,10/0,35	-	0,70/1,10	-	-
API 5L	GrA	Máx 0,22	Máx 0,90	0.04	0.05	Máx 0,50	-	2,00/2,50	-	-
	GrB	Máx 0,27	Máx 1,15	0.04	0.05	-	-	-	-	-
SAE 4140	-	Máx 0,38	Máx 0,75	0.03	0.04	Máx 0,15	-	Máx 0,80	Máx 0,15	-
	-	Máx 0,43	Máx 1,00			Mín 0,35	-	Mín 1,10	Mín 0,25	-
SAE 4340	-	Máx 0,38	Máx 0,60	0.03	0.04	Máx 0,15	Máx 1,65	Máx 0,70	Máx 0,20	-
	-	Máx 0,43	Máx 0,80			Mín 0,35	Mín 2,00	Mín 0,90	Mín 0,90	-
SAE 8620	-	Máx 0,18	Máx 0,70	0.03	0.04	Máx 0,15	Máx 0,40	Máx 0,40	Máx 0,15	-
	-	Máx 0,23	Máx 0,90			Mín 0,35	Mín 0,70	Mín 0,60	Mín 0,25	-
SAE 5160	-	Máx 0,56	Máx 0,75	0.03	0.04	Máx 0,15	-	Máx 0,70	-	-
	-	Máx 0,64	Máx 1,00			Mín 0,35	-	Mín 0,90	-	-

COMPOSICIÓN QUÍMICA DEL ACERO AL CARBONO

parte 5/6

Norma	Acero	Composición Química %								
		C	Mn	P. máx	S. Máx	Si	Ni	Cr	Mo	Cu
SAE 1020	-	Máx 0,18	Máx 0,30	0.03	0.05	-	-	-	-	-
	-	Máx 0,23	Máx 0,60			-	-	-	-	-
SAE 1045	-	Máx 0,43	Máx 0,60	0.03	0.05	-	-	-	-	-
	-	Máx 0,50	Máx 0,90			-	-	-	-	-
SAE 1060	-	Máx 0,55	Máx 0,60	0.03	0.05	-	-	-	-	-
	-	Máx 0,65	Máx 0,90			-	-	-	-	-

Norma	Acero	Propiedades Mecánicas		
		RT Mpa Mín.	Le Mpa Mín.	Dureza Máx.
5590 (ASTM A53)	GrA	330	205	-
	GrB	415	240	-
A 106	GrA	330	205	-
	GrB	415	240	-
	GrC	485	275	-
A 161	GrLC	324	179	-
	GrT1	379	207	-
A 178	GrA	325	180	-
	GrC	415	255	-
	SAC 50	490/602	373	-
A 179	A 179	415	170	72HB
A 192	A 192	-	-	137HB
A 199/200	GrT5	415	170	163HB
	GrT11	415	170	163HB
	GrT22	415	170	163HB

Norma	Acero	Propiedades Mecánicas		
		RT Mpa Mín.	Le Mpa Mín.	Dureza Máx.
A 209	GrT1	380	225	146HB
	GrT1a	415	220	153HB
	GrT1b	365	195	137HB
A 210	GrA1	415	255	143HB
	GrC	485	275	179HB
A 213	GrT2	415	205	163HB
	GrT5	415	205	179HB
	GrT11	415	205	163HB
	GrT12	415	205	163HB
	GrT22	415	205	163HB
A 214	A 214	-	-	72HB
A 226	A 226	325	180	125HB
A 333/334	Gr1	380	205	-
	Gr3	450	240	-

Norma	Acero	Propiedades Mecánicas		
		RT Mpa Mín.	Le Mpa Mín.	Dureza Máx.
A 333/334	Gr6	415	240	-
	Gr7	450	240	-
A 335	GrP1	380	205	-
	GrP2	380	205	-
	GrP5	415	205	-
	GrP11	415	205	-
	GrP12	415	205	-
	GrP22	415	205	-
A 423	Gr1	415	255	170HB
	Gr2	415	255	170HB
A 500	GrA	310	228	-
	GrB	400	290	-
	GrC	427	317	-
A 501	A 501	400	250	-

Norma	Acero	Propiedades Mecánicas		
		RT Mpa Mín.	Le Mpa Mín.	Dureza Máx.
DIN 1626	St 37.0	350/480	253	-
DIN 1629	St 44.0	420/550	275	-
	St 52.0	500/650	355	-
DIN 2391	St 35.0	340/470	235	-
	St 45.0	440/570	255	-
	St 52.0	490/630	355	-
	VMec 134AP	510	345	-
DIN 2393	St 34.2	310/410	205	145
	St 37.2	340/470	235	-
	St 42.0	-	-	-
	St 52.3	490/630	355	-
DIN 17175	VMec 134AP	510	343	-
	St 35.8	360/480	235	145

Norma	Acero	Propiedades Mecánicas		
		RT Mpa Mín.	Le Mpa Mín.	Dureza Máx.
DIN 17175	St 45.8	410/530	255	-
	15Mo3	450/600	270	-
	13CrMo44	440/590	290	-
	10CrMo910	450/600	280	-
API 5L	GrA	331	207	-
	GrB	413	241	-
SAE 4140	-	655	415	197HB
SAE 4340	-	745	470	217HB
SAE 8620	-	1157	833	341HB
SAE 5160	-	724	275	219HB
SAE 1020	-	420	350	121 HB
SAE 1045	-	585	450	163HB
SAE 1060	-	620	485	183HB

Calibre	"Masa lineal [kg/m]"	"Área A [cm ²]"	Espesor						EJE X - X			
			d [mm]	d [mm]	t _w [mm]	t _f [mm]	h mm	d' [mm]	I _x [cm ⁴]	W _x [cm ³]	r _x [cm]	Z _x [cm ⁴]
W 150 x 13,0	13,0	16,6	148	100	4,3	4,9	138,2	118,20	635	86	6,18	96
W 150 x 18,4	18,4	23,4	153	102	5,8	7,1	138,8	118,80	939	123	6,34	139
W 150 x 22,5	22,5	29,0	152	152	5,8	6,6	139,0	119,00	1229	162	6,51	180
W 150 x 29,8	29,8	38,5	157	153	6,6	9,3	138,0	118,00	1739	222	6,72	248
W 150 x 37,1	37,1	47,8	162	154	8,1	11,6	139,0	119,00	2224	277	6,85	314
W 200 x 15,0	15,2	19,4	200	100	4,3	5,2	189,6	169,60	1305	130	8,20	148
W 200 x 19,3	19,7	25,1	203	102	5,8	6,5	190,0	170,00	1686	166	8,19	191
W 200 x 22,5	22,7	29,0	206	102	6,2	8,0	190,0	170,00	2029	197	8,37	226
W 200 x 26,6	26,9	34,2	207	133	5,8	8,4	190,2	170,20	2611	252	8,73	282
W 200 x 31,3	31,7	40,3	210	134	6,4	10,2	189,6	169,60	3168	302	8,86	339
W 200 x 35,9	35,9	45,7	201	165	6,2	10,2	181,0	161,00	3437	342	8,67	380

Calibre	"Masa lineal [kg/m]"	"Área A [cm ²]"	Espesor					EJE X - X				
			d [mm]	d [mm]	t _w [mm]	t _f [mm]	h mm	d' [mm]	I _x [cm ⁴]	W _x [cm ³]	r _x [cm]	Z _x [cm ⁴]
W 200 x 46,1	46,0	58,6	203	203	7,2	11,0	181,0	161,00	4543	448	8,81	495
W 250 x 17,9	18,1	23,1	251	101	4,8	5,3	240,4	220,40	2291	183	9,96	211
W 250 x 22,3	22,7	28,9	254	102	5,8	6,9	240,2	220,20	2939	231	10,09	268
W 250 x 25,3	25,6	32,6	257	102	6,1	8,4	240,2	220,20	3473	270	10,31	311
W 250 x 28,4	28,7	36,6	260	102	6,4	10,0	240,0	220,00	4046	311	10,51	357
W 250 x 32,7	33,0	42,1	258	146	6,1	9,1	239,8	219,80	4937	383	10,83	429
W 250 x 38,5	38,9	49,6	262	147	6,6	11,2	239,6	219,60	6057	462	11,05	518
W 250 x 44,8	45,2	57,6	266	148	7,6	13,0	240,0	220,00	7158	538	11,15	606
W 250 x 73,0	72,8	92,7	253	254	8,6	14,2	224,6	200,60	11257	890	11,02	983
W 250 x 80,0	80,0	101,9	256	255	9,4	15,6	224,8	200,80	12550	980	11,10	1089
W 250 x 89,0	89,4	113,9	260	256	10,7	17,3	225,4	201,40	14237	1095	11,18	1224
W 310 x 21,0	21,4	27,2	303	101	5,1	5,7	291,6	271,60	3776	249	11,77	292
W 310 x 23,8	24,1	30,7	305	101	5,6	6,7	291,6	271,60	4346	285	11,89	333

Calibre	"Masa lineal [kg/m]"	"Área A [cm ²]"	Espesor					EJE X - X				
			d [mm]	d [mm]	t _w [mm]	t _f [mm]	h mm	d' [mm]	I _x [cm ⁴]	W _x [cm ³]	r _x [cm]	Z _x [cm ⁴]
W 310 x 28,3	28,6	36,5	309	102	6,0	8,9	291,2	271,20	5500	356	12,28	412
W 310 x 32,7	33,1	42,1	313	102	6,6	10,8	291,4	271,40	6570	420	12,49	485
W 310 x 38,7	39,0	49,7	310	165	5,8	9,7	290,6	270,60	8581	554	13,14	615
W 310 x 44,5	44,9	57,2	313	166	6,6	11,2	290,6	270,60	9997	639	13,22	713
W 310 x 52,0	52,6	67,0	317	167	7,6	13,2	290,6	270,60	11909	751	13,33	842
W 310 x 97,0	97,0	123,6	308	305	9,9	15,4	277,2	245,20	22284	1447	13,43	1594
W 310 x 107,0	107,1	136,4	311	306	10,9	17,0	277,0	245,00	24839	1597	13,49	1768
W 310 x 117,0	117,7	149,9	314	307	11,9	18,7	276,6	244,60	27563	1756	13,56	1953
W 360 x 32,9	33,0	42,1	349	127	5,8	8,5	332,0	308,00	8358	479	14,09	548
W 360 x 39,0	39,4	50,2	353	128	6,5	10,7	331,6	307,60	10331	585	14,35	668
W 360 x 44,0	45,3	57,7	352	171	6,9	9,8	332,4	308,40	12258	696	14,58	784
W 360 x 51,0	50,9	64,8	355	171	7,2	11,6	331,8	307,80	14222	801	14,81	900
W 360 x 57,8	56,9	72,5	358	172	7,9	13,1	331,8	307,80	16143	902	14,92	1015

Calibre	"Masa lineal [kg/m]"	"Área A [cm ²]"	Espesor					EJE X - X				
			d [mm]	d [mm]	t _w [mm]	t _f [mm]	h mm	d' [mm]	I _x [cm ⁴]	W _x [cm ³]	r _x [cm]	Z _x [cm ⁴]
W 360 x 64,0	64,1	81,7	347	203	7,7	13,5	320,0	288,00	17890	1031	14,80	1146
W 360 x 72,0	71,7	91,3	350	204	8,6	15,1	319,8	287,80	20169	1152	14,86	1286
W 360 x 79,0	79,4	101,2	354	205	9,4	16,8	320,4	288,40	22713	1283	14,98	1437
W 410 x 38,8	39,5	50,3	399	140	6,4	8,8	381,4	357,40	12777	640	15,94	737
W 410 x 46,1	46,5	59,2	403	140	7,0	11,2	380,6	356,60	15690	779	16,27	891
W 410 x 53,0	53,7	68,4	403	177	7,5	10,9	381,2	357,20	18734	930	16,55	1052
W 410 x 60,0	59,8	76,2	407	178	7,7	12,8	381,4	357,40	21707	1067	16,88	1201
W 410 x 67,0	67,8	86,3	410	179	8,8	14,4	381,2	357,20	24678	1204	16,91	1363
W 410 x 75,0	75,2	95,8	413	180	9,7	16,0	381,0	357,00	27616	1337	16,98	1519
W 460 x 52,0	52,3	66,6	450	152	7,6	10,8	428,4	404,40	21370	950	17,91	1096
W 460 x 60,0	59,8	76,2	455	153	8,0	13,3	428,4	404,40	25652	1128	18,35	1292
W 460 x 68,0	68,8	87,6	459	154	9,1	15,4	428,2	404,20	29851	1301	18,46	1495

Calibre	"Masa lineal [kg/m]"	"Área A [cm ²]"	Espesor						EJE X - X			
			d [mm]	d [mm]	t _w [mm]	t _f [mm]	h mm	d' [mm]	I _x [cm ⁴]	W _x [cm ³]	r _x [cm]	Z _x [cm ⁴]
W 460 x 74,0	74,5	94,9	457	190	9,0	14,5	428,0	404,00	33415	1462	18,77	1657
W 460 x 82,0	82,2	104,7	460	191	9,9	16,0	428,0	404,00	37157	1616	18,84	1836
W 460 x 89,0	89,6	114,1	463	192	10,5	17,7	427,6	403,60	41105	1776	18,98	2019
W 530 x 66,0	65,6	83,6	525	165	8,9	11,4	502,2	478,20	34971	1332	20,46	1558
W 530 x 72,0	71,9	91,6	524	207	9,0	10,9	502,2	478,20	39969	1526	20,89	1756
W 530 x 74,0	74,6	95,1	529	166	9,7	13,6	501,8	477,80	40969	1549	20,76	1805
W 530 x 82,0	82,0	104,5	528	209	9,5	13,3	501,4	477,40	47569	1802	21,34	2059
W 530 x 85,0	84,6	107,7	535	166	10,3	16,5	502,0	478,00	48453	1811	21,21	2100
W 530 x 92,0	92,3	117,6	533	209	10,2	15,6	501,8	477,80	55157	2070	21,65	2360
W 610 x 101,0	102,3	130,3	603	228	10,5	14,9	573,2	541,20	77003	2554	24,31	2923
W 610 x 113,0	114,1	145,3	608	228	11,2	17,3	573,4	541,40	88196	2901	24,64	3313
W 610 x 155,0	155,5	198,1	611	324	12,7	19,0	573,0	541,00	129583	4242	25,58	4749
W 610 x 174,0	174,9	222,8	616	325	14,0	21,6	572,8	540,80	147754	4797	25,75	5383

PERFIL EN "U" - EN EL ESTÁNDAR AMERICANO

parte 1/1

Tamaño Nominal		Altura (A)		Peso	Ancho de las Aalas (B)		Espesor del Alma (C.)	
mm	pulgada	mm	pulgada		kg/m	mm	pulgada	mm
76,20 x 38,10	3" x 1.1/2"	76,20	3"	6,10	35,81	1,410	4,32	0,170
				7,44	38,05	1,498	6,55	0,258
				8,93	40,54	1,596	9,04	0,356
101,60 x 41,28	4" x 1.5/8"	101,60	4"	8,04	40,13	1,580	4,57	0,180
				9,30	41,83	1,647	6,27	0,247
				10,79	43,69	1,720	8,13	0,320
152,40 x 50,80	6" x 2"	152,40	6"	12,20	48,77	1,920	5,08	0,200
				15,63	51,66	2,034	7,98	0,314
				19,35	54,79	2,157	11,10	0,437
203,20 x 57,15	8" x 2.1/4"	203,20	8"	23,07	57,89	2,279	14,20	0,559
				17,11	57,40	2,260	5,59	0,220
				20,46	59,51	2,343	7,70	0,303
254,00 x 66,68	10" x 2.5/8"	254,00	10"	24,18	61,85	2,435	10,03	0,395
				27,90	64,19	2,527	12,37	0,487
				31,62	66,52	2,619	14,71	0,579
304,80 x 76,20	12" x 3"	304,80	12"	22,77	66,04	2,600	6,10	0,240
				29,76	69,57	2,739	9,63	0,379
				37,20	73,30	2,886	13,36	0,526
381,00 x 85,73	15" x 3.3/8"	381,00	15"	44,65	77,04	3,033	17,09	0,673
				52,09	80,77	3,180	20,83	0,820
				30,81	74,68	2,940	7,11	0,280
304,80 x 76,20	12" x 3"	304,80	12"	37,20	77,39	3,047	9,83	0,387
				44,65	80,52	3,170	12,95	0,510
				52,09	83,62	3,292	16,05	0,632
381,00 x 85,73	15" x 3.3/8"	381,00	15"	59,53	86,74	3,415	19,18	0,755
				50,45	86,36	3,400	10,16	0,400
				52,09	86,92	3,422	10,72	0,422
381,00 x 85,73	15" x 3.3/8"	381,00	15"	59,53	89,41	3,520	13,21	0,520
				66,97	91,90	3,618	15,70	0,618
				74,41	94,39	3,716	18,19	0,716
				81,85	96,88	3,814	20,68	0,814

BARRAS RECTANGULARES - HIERRO PLANO

parte 1/2

Tablón Dimensiones en pulgadas			Tablón Dimensiones en pulgadas			Tablón Dimensiones en pulgadas			Tablón Dimensiones en pulgadas		
Espesor	Ancho	Kg/m	Espesor	Ancho	Kg/m	Espesor	Ancho	Kg/m	Espesor	Ancho	Kg/m
1/8"	5/8"	0,4	3/8"	1"	1,9	1/4"	3/4"	0,95	5/8"	1"	3,16
	3/4"	0,48		1.1/4"	2,38		7/8"	1,11		1.1/4"	3,95
	7/8"	56		1.1/2"	2,85		1"	1,27		1.1/2"	4,75
	1"	0,63		2"	3,8		1.1/4"	1,58		2"	6,33
	1.1/4"	0,79		2.1/2"	4,74		1.1/2"	1,9		2.1/2"	7,91
	1.1/2"	0,95		3"	5,7		2"	2,53		3"	9,5
	1.3/4"	1,11		4"	7,6		2.1/2"	3,17		3.1/2"	11,08
	2"	1,27		1"	2,53		3"	3,8		4"	12,66
3/16"	3/4"	0,71	1/2"	1.1/4"	3,17		4"	5,06			
	7/8"	0,83		1.1/2"	3,8						
	1"	0,95		2"	5,06						
	1.1/4"	1,19		2.1/2"	6,33						
	1.1/2"	1,42		3"	7,6						
	2"	1,66	4"	10,13							













BARRAS RECTANGULARES - HIERRO PLANO

parte 2/2













Tablón Dimensiones en pulgadas			Tablón Dimensiones en pulgadas		
Espesor	Ancho	Kg/m	Espesor	Ancho	Kg/m
5/16"	3/4"	1,19	3/4"	1"	3,8
	7/8"	1,4		1.1/4"	4,74
	1"	1,58		1.1/2"	5,7
	1.1/4"	1,98		2"	7,6
	1.1/2"	2,38		2.1/2"	9,5
	2"	3,17		3"	11,4
	2.1/2"	3,96		3.1/2"	13,29
	3"	4,75		4"	15,19
3/8"	4"	6,33	1"	2"	10,12
	3/4"	1,42		2.1/2"	12,66
	7/8"	1,68		3"	15,19
				4"	20,26

BARRAS REDONDAS CUADRADAS Y HEXAGONALES

parte 1/2

Calibre		Kg/m			Calibre		Kg/m			Calibre		Kg/m			Calibre		Kg/m		
Pulgadas	mm				Pulgadas	mm				Pulgadas	mm				Pulgadas	mm			
1/8	3,17	0,062	-	-	1	25,40	3,97	5,06	4,38	1.15/16	49,21	14,92	18,99	16,45	2.7/8	73,02	32,85	41,82	36,22
5/32	3,97	0,097	-	-	1.1/16	26,99	4,49	5,71	4,95	2	50,8	15,9	20,24	17,53	2.15/16	74,61	34,29	43,66	37,81
3/16	4,76	0,140	0,18	0,15	1.1/8	28,57	5,03	6,4	5,55	2.1/16	53,39	16,91	21,52	18,64	3	76,20	35,77	45,54	39,43
1/4	6,35	0,25	0,32	0,27	1.3/16	30,16	5,60	7,14	6,18	2.1/8	53,97	17,95	22,85	19,79	3.1/8	79,38	38,81	49,41	42,79
5/196	7,94	0,39	0,49	0,43	1.1/4	31,75	6,21	7,91	6,85	2.3/16	55,56	19,02	24,21	20,97	3.1/4	82,55	41,88	53,44	46,34
3/8	9,53	0,56	0,71	0,62	1.5/16	33,34	6,85	8,72	7,55	2.1/4	57,15	20,12	25,62	22,19	3.3/8	85,73	42,27	57,63	49,98
7/16	11,11	0,76	0,97	0,84	1.3/8	34,92	7,51	9,57	8,29	2.6/16	58,74	21,25	27,06	23,44	3.1/2	88,90	48,68	61,98	53,74
1/2	12,7	0,99	1,22	1,10	1.7/16	36,51	8,21	10,46	9,06	2.3/8	60,32	22,42	28,54	24,72	3.5/8	92,08	52,22	66,49	-
9/16	14,29	1,26	1,60	1,39	1.1/2	38,10	8,94	11,39	9,86	2.7/16	61,91	23,61	30,06	26,03	3.3/4	95,25	55,88	71,15	-
5/8	15,87	1,55	1,98	1,71	1.9/16	39,69	9,70	12,35	10,7	2.1/2	63,50	24,84	31,62	27,38	3.7/8	94,43	60,67	75,98	-
11/16	17,46	1,88	2,36	2,07	1.5/8	41,27	10,49	13,36	11,57	2.9/16	65,09	26,10	33,22	28,78	4	101,6	63,58	80,96	-
3/4	19,05	2,24	2,85	2,46	1.11/16	42,86	11,32	14,41	12,48	2.5/8	66,67	27,38	34,87	30,79	4.1/8	104,78	67,62	86,10	-
13/16	20,64	2,62	3,34	2,89	1.3/4	44,45	12,17	15,5	13,42	2.11/16	68,26	28,70	36,55	31,67					
7/8	22,22	3,04	3,87	3,35	1.13/16	46,04	13,06	16,62	14,4	2.3/4	69,85	30,05	38,27	33,14					
15/16	23,81	3,49	4,45	3,85	1.7/8	47,62	13,97	17,79	15,41	2.13/16	71,44	31,44	40,02	34,22					

BARRAS REDONDAS CUADRADAS Y HEXAGONALES

Calibre					Kg/m					Calibre					Kg/m				
Pulgadas	mm				Pulgadas	mm				Pulgadas	mm				Pulgadas	mm			
4.1/4	107,95	71,78	91,39	-	7.1/4	184,15	209,70	266,20	-	11	279,40	481,20	612,80	-	19	482,60	1434,60	1826,60	-
4.3/8	111,13	76,06	96,85	-	7.1/2	190,50	223,80	285,00	-	11.1/4	285,75	503,40	641,00	-	20	508,00	1589,50	2023,90	-
4.1/2	114,30	80,47	102,46	-	7.3/4	196,85	238,90	304,00	-	11.1/2	292,70	526,00	669,80	-	21	533,40	1752,61	2230,60	-
4.5/8	117,48	85,01	108,23	-	8	203,20	254,60	324,00	-	11.3/4	298,45	549,00	699,20	-	22	558,80	1932,50	2448,09	-
4.3/4	120,65	89,66	114,16	-	8.1/4	209,55	270,70	345,00	-	12	304,80	572,70	729,30	-	23	584,20	2102,34	2675,71	-
4.7/8	123,83	94,44	120,25	-	8.1/2	215,90	287,40	365,90	-	12.1/2	317,50	620,90	790,60	-	24	609,60	2289,13	2913,43	-
5	127,00	99,80	126,50	-	8.3/4	222,25	304,60	388,50	-	13	330,20	672,60	855,80	-	25	635,00	2483,86	3161,28	-
5.1/4	133,35	109,50	139,50	-	9	228,60	322,10	410,20	-	13.1/2	342,90	724,30	922,20	-	26	660,40	2686,54	3419,24	-
5.1/2	139,70	120,20	153,10	-	9.1/4	234,95	340,30	433,50	-	14	355,60	779,70	992,60	-	27	685,80	2897,18	3687,32	-
5.3/4	146,05	131,40	167,20	-	9.1/2	241,30	359,00	457,10	-	14.1/2	368,30	835,50	1063,80	-	28	711,20	3115,76	3965,51	-
6	152,40	143,10	182,50	-	9.3/4	247,65	378,10	481,40	-	15	381,00	894,90	1139,50	-	29	736,60	3342,29	4253,82	-
6.1/4	158,75	155,20	197,80	-	10	254,00	397,80	506,50	-	15.1/2	393,70	954,70	1215,60	-	30	762,00	3576,76	4552,24	-
6.1/2	165,10	167,90	213,50	-	10.1/4	260,35	417,90	532,00	-	16	406,50	1017,30	1295,30	-					
6.3/4	171,45	181,10	231,00	-	10.1/2	266,70	438,50	558,40	-	17	431,80	1148,60	1462,30	-					
7	177,80	194,70	284,10	-	10.3/4	273,05	459,70	585,30	-	18	457,20	1287,60	1639,40	-					

TUBOS ESTÁNDAR SCHEDULE

parte 2/5

Ø Nominal	Ø Externo (mm)	Denominación	Schedule	Espesor de la pared (mm)	Peso por metro	Ø Nominal	Ø Externo (mm)	Denominación	Schedule	Espesor de la pared (mm)	Peso por metro
5"	141,30	STD	40	6,55	21,75	10"	273,05		20	6,35	41,74
		XS	80	9,52	30,92				30	7,80	50,95
			120	12,70	40,25			STD	40	9,27	60,23
			160	15,88	49,01			XS	60	12,70	81,45
		XXS		19,05	57,36				80	15,09	95,87
6"	168,28	STD		6,35	25,33				100	18,26	114,62
			40	7,11	28,23				120	21,44	132,86
		XS	80	10,97	42,51			XXS	140	25,40	154,95
			120	14,27	54,15				160	28,57	172,07
			160	18,26	67,48				20	6,35	49,67
8"	219,08	XXS		21,95	79,10	STD	30	8,38	65,13		
			20	6,35	33,27		40	10,31	79,64		
			30	7,04	36,75	XS		12,70	97,34		
		STD	40	8,18	42,48		60	14,27	108,85		
			60	10,31	53,03		80	17,47	131,88		
		XS	80	12,70	64,56		100	21,44	159,69		
			100	15,09	75,81	XXS	120	25,40	186,73		
			120	18,26	90,47		140	28,57	207,83		
			140	20,62	100,83		160	33,32	238,49		
		XXS		22,22	107,76						
	160	23,01	111,14								

TUBOS ESTÁNDAR SCHEDULE

parte 3/5

Ø Nominal	Ø Externo (mm)	Denominación	Schedule	Espesor de la pared (mm)	Peso por metro	Ø Nominal	Ø Externo (mm)	Denominación	Schedule	Espesor de la pared (mm)	Peso por metro								
14"	355,60		10	6,35	54,68	18"	457,20		10	6,35	70,52								
			20	7,92	67,87				20	7,92	87,70								
			STD	30	9,52				81,20	STD	30	11,13	122,24						
			XS	40	11,13				94,40	XS	40	14,27	155,75						
				60	15,19				126,56		60	19,05	205,60						
			16"	406,40					80	19,05	157,92				80	23,83	254,33		
									100	23,82	194,70				100	29,36	309,44		
									120	27,79	224,38				120	34,92	363,28		
									140	31,75	253,27				140	39,67	408,04		
									160	35,71	281,40				160	45,25	459,05		
						10	6,35	62,57	20"	508,00					10	6,35	78,47		
						20	7,92	77,78							STD	20	9,53	116,97	
						STD	30	9,52							93,16	XS	30	12,70	154,97
						XS	40	12,70							123,16		40	15,09	183,14
							60	16,66							159,96	60	20,62	247,78	
						80	21,44	203,28							80	26,19	310,91		
						100	26,19	245,25							100	32,54	381,20		
						120	30,96	286,34							120	38,10	441,06		
						140	36,53	332,78							140	44,45	507,63		
						160	40,49	364,93							160	50,01	564,24		

TUBOS ESTÁNDAR SCHEDULE

parte 4/5

Ø Nominal	Ø Externo (mm)	Denominación	Schedule	Espesor de la pared (mm)	Peso por metro	Ø Nominal	Ø Externo (mm)	Denominación	Schedule	Espesor de la pared (mm)	Peso por metro
22"	558,80	XS	10	6,35	86,41	26"	660,40	STD	20	6,35	102,30
			20	9,52	128,88					9,52	152,71
			30	12,70	182,32					12,70	202,62
			40	15,88	212,31					15,88	252,04
			60	22,22	293,75					17,48	276,75
			80	28,57	373,21					19,05	300,95
			100	34,92	450,69					6,35	110,25
			120	41,27	526,17					9,53	164,63
			140	47,62	599,66					12,70	218,51
			160	53,97	671,15					15,88	271,90
24"	609,60	STD	10	6,35	94,35	28"	711,20	XS	20	12,70	186,73
			20	9,52	140,80					17,48	298,61
			30	14,27	209,33					19,05	324,79
			40	17,48	254,88					6,35	118,19
			60	24,61	354,66					9,53	176,55
			80	30,96	441,31					12,70	234,40
			100	38,89	546,68					15,88	291,77
			120	46,02	638,93					17,48	320,49
			140	52,37	718,88					19,05	350,62
			160	59,53	807,50					6,35	126,14
24"	609,60	XS	10	6,35	94,35	30"	762,00	STD	20	9,53	188,47
			20	9,52	140,80					12,70	250,30
			30	14,27	209,33					15,88	311,63
			40	17,48	254,88					17,48	342,36
			60	24,61	354,66					19,05	372,46
			80	30,96	441,31					6,35	126,14
			100	38,89	546,68					9,53	188,47
			120	46,02	638,93					12,70	250,30
			140	52,37	718,88					15,88	311,63
			160	59,53	807,50					17,48	342,36
26"	660,40	STD	10	6,35	94,35	32"	812,80	XS	20	12,70	186,73
			20	9,52	140,80					15,88	271,90
			30	12,70	182,32					17,48	298,61
			40	15,88	212,31					19,05	324,79
			60	22,22	293,75					6,35	110,25
			80	28,57	373,21					9,53	164,63
			100	34,92	450,69					12,70	218,51
			120	41,27	526,17					15,88	271,90
			140	47,62	599,66					17,48	298,61
			160	53,97	671,15					19,05	324,79

TUBOS ESTÁNDAR SCHEDULE

parte 5/5

Ø Nominal	Ø Externo (mm)	Denominación	Schedule	Espesor de la pared (mm)	Peso por metro
34"	863,60			6,35	134,08
		STD	20	9,53	200,39
		XS	30	12,70	266,16
			40	15,88	331,50
				17,48	364,22
				19,05	396,74
36"	914,40			6,35	142,03
		STD		9,53	212,31
		XS	20	12,70	282,08
			30	15,88	351,36
				17,48	386,09
				19,05	420,14
38"	965,20			6,35	151,29
		STD		9,53	224,23
		XS		12,70	297,97
				15,88	371,23
				17,48	407,95
				19,05	443,97
40"	1016,00			6,35	159,34
		STD		9,53	236,15
		XS		12,70	313,86
				15,88	391,09
				17,48	429,82
				19,05	467,81

 fórmulas para

cálculos

Fórmulas

FÓRMULAS PARA CÁLCULOS

BARRAS

Cuadradas

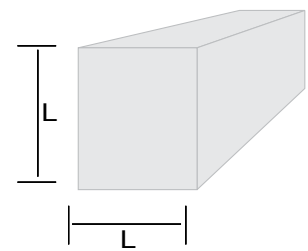

$$\text{Peso en kg/m} = \frac{L^2 \times \rho}{1.000}$$

Redondas

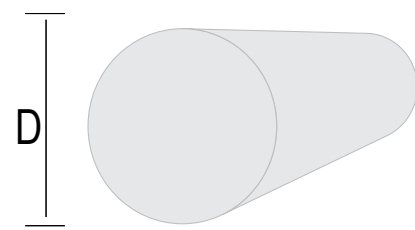

$$\text{Peso en kg/m} = \frac{D^2 \times 0.7854 \times \rho}{1.000}$$

Hexagonales

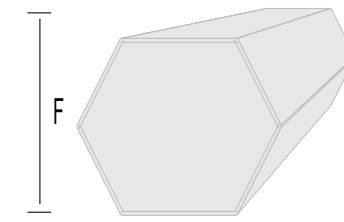

$$\text{Peso en kg/m} = \frac{F^2 \times 0.8660 \times \rho}{1.000}$$

Rectangulares con esquinas vivas

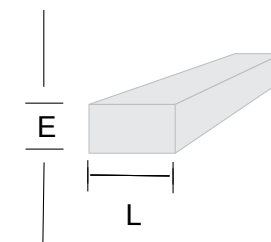

$$\text{Peso en kg/m} = \frac{L \times E \times \rho}{1.000}$$

TUBOS

Redondos

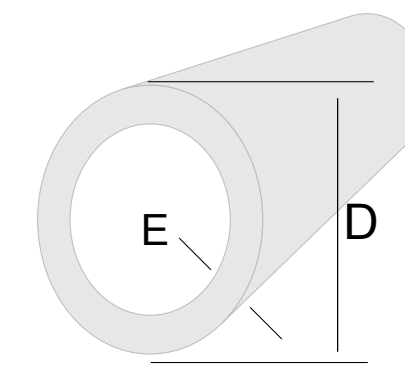

$$\text{Peso en kg/m} = \frac{(D - E) \times E \times \pi \times \rho}{1.000}$$

Cuadrados

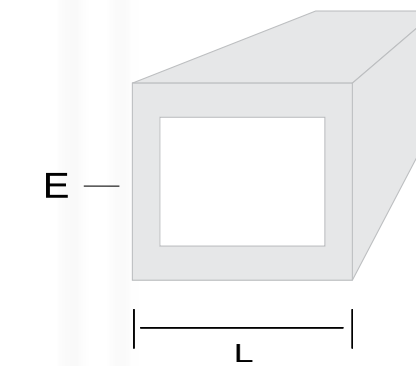

$$\text{Peso en kg/m} = \frac{[(2 \times L) - (2 \times E)] \times 2 \times E \times \rho}{1.000}$$

Rectangulares con esquinas vivas

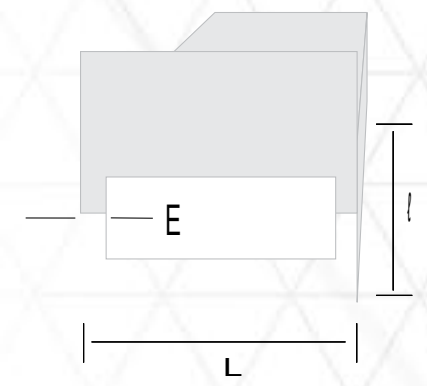

$$\text{Peso en kg/m} = \frac{[(L + t) - (2 \times E)] \times (2 \times E) \times \rho}{1.000}$$

CHAPAS

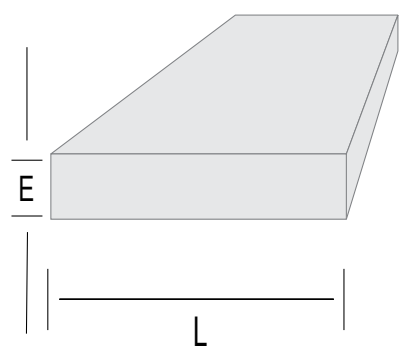

$$\text{Peso en kg /pieza} = \frac{C \times L \times E \times \rho}{1.000.000}$$

PERFIS

Perfil "L" - Esquina

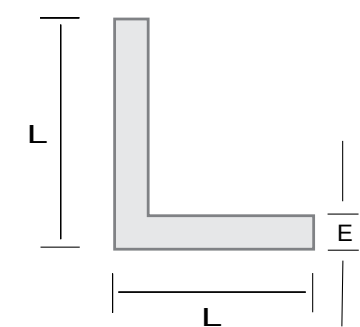

$$\text{Peso en kg/m} = \frac{(2 \times L \times E - E^2) \times \rho}{1.000}$$

Perfil "T"

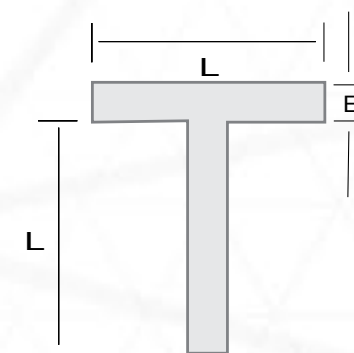

$$\text{Peso en kg/m} = \frac{(2 \times L \times E - E^2) \times \rho}{1.000}$$

Perfil "U" - Pestañas iguales

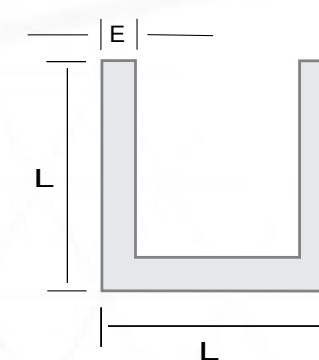

$$\text{Peso en kg/m} = \frac{(3 \times L \times E) - (2 \times E^2) \times \rho}{1.000}$$

Perfil "U" - Pestañas desiguales

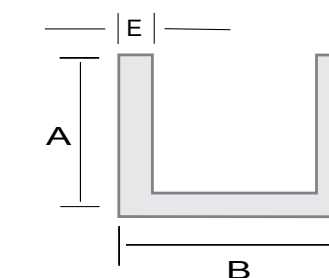

$$\text{Peso en kg/m} = \frac{[(2 \times A + B) \times E] - (2 \times E^2) \times \rho}{1.000}$$

TABLA DE CONVERSIÓN

Pulgadas	MM
1/32"	0,79
1/16"	1,58
3/32"	2,38
1/8"	3,18
5/32"	3,97
3/16"	4,76
7/32"	5,56
1/4"	6,35
9/32"	7,14
5/16"	7,94
11/32"	8,73
3/8"	9,53
13/32"	10,32
7/16"	11,11
15/32"	11,91
1/2"	12,7
17/32"	13,49
9/16"	14,29
19/32"	15,08
5/8"	15,87
21/32"	16,67
11/16"	17,46
23/32"	18,26
3/4"	19,05
25/32"	19,84
13/16"	20,64
27/32"	21,43
7/8"	22,22

Pulgadas	MM
29/32"	23,02
15/16"	23,81
31/32"	24,61
1"	25,4
1.1/32"	26,19
1.1/16"	26,99
1.3/32"	27,78
1.1/8"	28,57
1.5/32"	29,37
1.3/16"	30,16
1.7/32"	30,95
1.1/4"	31,75
1.9/32"	32,54
1.5/16"	33,34
1.11/32"	34,13
1.3/8"	34,92
1.13/32"	35,72
1.7/16"	36,51
1.15/32"	37,30
1.1/2"	38,10
1.17/32"	38,89
1.9/16"	39,69
1.19/32"	40,48
1.5/8"	41,27
1.21/32"	42,07
1.11/16"	42,86
1.23/32"	43,65
1.3/4"	44,45

Pulgadas	MM
1.25/32"	45,24
1.13/16"	46,04
1.27/32"	46,83
1.7/8"	47,62
1.29/32"	48,42
1.15/16"	49,21
1.31/32"	50,00
2"	50,80
2.1/16"	52,39
2.1/8"	53,97
2.3/16"	55,58
2.1/4"	57,15
2.5/16"	58,74
2.3/8"	60,32
2.7/16"	61,91
2.1/2"	63,50
2.9/16"	65,09
2.5/8"	66,67
2.11/16"	68,26
2.3/4"	69,85
2.13/16"	71,44
2.7/8"	73,02
2.15/16"	74,61
3"	76,20
3.1/8"	79,38
3.1/4"	82,55
3.3/8"	85,78
3.1/2"	88,90

Pulgadas	MM
3.5/8"	92,08
3.3/4"	95,25
3.7/8"	98,43
4"	101,60
4.1/4"	107,95
4.1/2"	114,30
4.3/4"	120,65
5"	127,00
5.1/4"	133,35
5.1/2"	139,70
5.3/4"	146,05
6"	152,40
6.1/4"	158,75
6.1/2"	165,10
6.3/4"	171,45
7"	177,80
7.1/4"	184,15
7.1/2"	190,50
7.3/4"	196,85
8"	203,20
8.1/4"	209,55
8.1/2"	215,90
8.3/4"	222,25
9"	228,60
9.1/4"	234,95
9.1/2"	241,30
9.3/4"	247,65
10"	254,00

Pulgadas	MM
10.1/4"	260,35
10.1/2"	266,70
10.3/4"	273,05
11"	279,40
11.1/4"	285,75
11.1/2"	292,70
11.3/4"	298,45
12"	304,80
12.1/4"	311,15
12.1/2"	317,50
12.3/4"	323,85
13"	330,20
13.1/4"	336,55
13.1/2"	342,90
13.3/4"	349,25
14"	355,60
14.1/4"	361,95
14.1/2"	368,30
14.3/4"	374,65
15"	381,00
15.1/4"	387,35
15.1/2"	393,70
15.3/4"	400,05
16"	406,40
16.1/4"	412,75
16.1/2"	419,10
16.3/4"	425,45
17"	431,80

Pulgadas	MM
17.1/4"	438,15
17.1/2"	444,50
17.3/4"	450,85
18"	457,20
18.1/4"	463,55
18.1/2"	469,90
183/4"	476,25
19"	482,60
19.1/4"	488,95
19.1/2"	495,30
19.3/4"	501,65
20"	508,00
20.1/4"	514,35
20.1/2"	520,70
20.3/4"	527,05
21"	533,40
21.1/4"	539,75
21.1/2"	546,10
21.3/4"	552,45
22"	558,80
22.1/4"	565,15
22.1/2"	571,50
22.3/4"	577,85
23"	584,20
23.1/4"	590,55
23.1/2"	596,90
23.3/4"	603,25
24"	609,60

Coppermetal

¡FUNCIONAL COMO EL ALUMINIO, SÓLIDO COMO ACERO Y EFICIENTE COMO EL COBRE!

Nuestro compromiso con la calidad de los productos y la atención de excelencia son diferenciales que llevamos con orgullo.

Nuestro equipo está compuesto por profesionales altamente competentes y atentos. Para Coppermetal, cada negociación y cada cliente es único y merece lo mejor que podemos entregar.

¡Estamos seguros de que nuestra asociación será productiva, agregada y rentable para usted y nuestra empresa!

CONTACTOS

www.coppermetal.com.br

55 (11) 5547-8337

**Rua Neuchatel, 369 - Capela do Socorro
São Paulo - Cep: 04781-030**

¡Gracias!

